

Date: 14 Jan., 2021

2D Lidar UGM-50LXN (UUGM003) Specification

CE
RoHS

$\Delta \times 1$	Error correction	p.13	14 Jan.,2021	Sakamoto	RS-01606
Symbol	Amended reason	Pages	Date	Corrector	Amended No.
Approved by	Checked by	Drawn by	Designed by	Title UGM-50LXN Specification	Drawing No.
<i>T.kamitani</i>	<i>T.Kamon</i>	N. Sakamoto	N. Sakamoto		

General

- The UGM-50LXN scans a semicircular field using a laser beam ($\lambda= 905 \text{ nm}$), then calculates coordinates by measuring the distance to an object and its corresponding step angle and detects obstacles within the setting area.
- This product can output distance data using the communication protocol SCIP.
- This product is Class 1 laser product.
- You can set scan speed / angular resolution from three modes.
- It is possible to reduce the influence of interference between multiple units of this product using the synchronized rotation of the motor inside products. This function synchronizes the motor rotation to an external reference signal.
- The UGM-50LXN has a function of the dirt detection (contamination detection) on the optical window. This product can output a control signal when detecting dirt on the optical window.

1. Configuration (Laser scanning image)

In normal mode

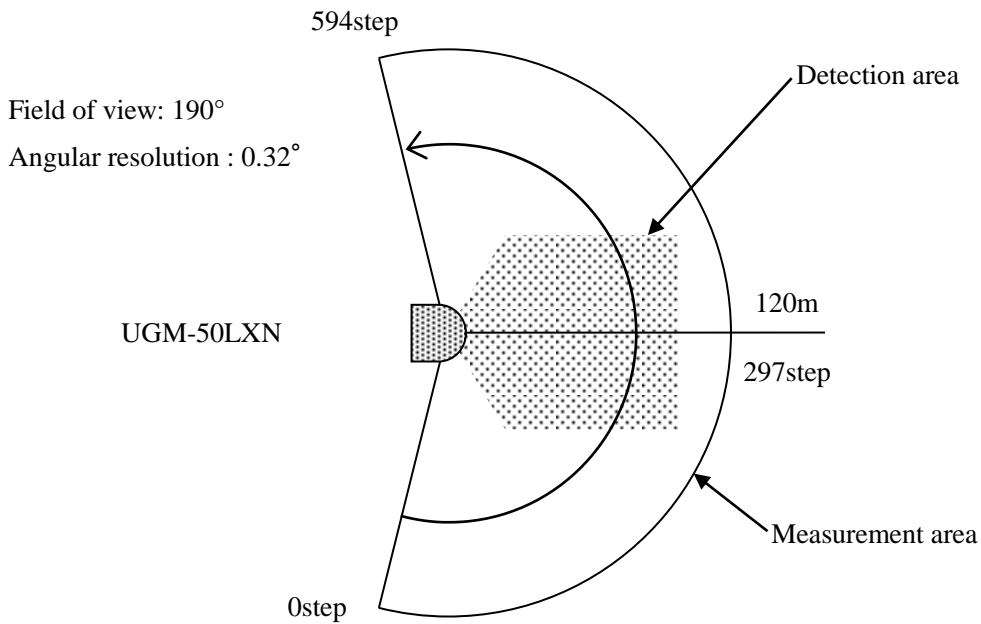

The specifications in normal mode, low speed mode, and high resolution mode are as follows.

Angular resolution/ Scan speed	Angular resolution	Field of view	Step	Front step
Normal mode 20ms /3000rpm	0.32°	190°	0 to 594step	297step
Low speed mode 40ms /1500rpm	0.16°	190°	0 to 1188step	594step
High resolution mode 80ms / 750rpm	0.08°	190°	0 to 2376step	1188step

Title	UGM-50LXN Specification	Drawing. No.	C-42-04477	2/13
-------	-------------------------	-----------------	------------	------

2. Disclaimer

- The UGM-50LXN (hereafter referred as sensor) is not certified for functional safety.
- This sensor cannot be used for human body detection as per the machinery directives.
- This sensor emits laser for measurement. Sensor's operation may become unstable under the influence of strong interference light or when emitted lights are not reflected back from object.
- The sensor's operation may become unstable due to rain, snow and fog or due to dust pollution on the optical window.
- Rules and regulations related to safety should be followed strictly when machine users and system designers operates the sensor.
- When there is a risk that the this sensor is used for weapons of mass destruction, weapons and equipment aimed at killing human beings, and relevant technologies, etc., or when its usage for those purposes has become clear, sales may be prohibited in accordance with the Foreign Exchange and Foreign Trade Act, and the Export Trade Control Order (Japanese law). Moreover, regarding export of products, the formalities according to laws/Export Trade Control Order are implemented in order to maintain international peace and safety.
- Use of controls or adjustments or performance of procedures other than those specified herein may result in hazardous radiation exposure.
- Before using the sensor, please read carefully and understand this specification.

Title	UGM-50LXN Specification	Drawing. No.	C-42-04477	3/13
-------	-------------------------	-----------------	------------	------

3. Specification

Product name	2D LiDAR
Model	UGM-50LXN
Light source	Laser semi-conductor (905nm), FDA Laser Safety Class 1 (IEC60825-1:2014)
Supply voltage	DC 24V±10%
Supply current	Steady state current : 1A or less, Starting current : 1.5A or less, without Heater* ¹
Power consumption	24W or less (Steady state and current)
Heater voltage	DC24V
Heater current	Steady state and Starting current : 2A or less, Only Heater* ²
Heater power consumption	48W or less
Detection range and object	Guarantee detection range: 0.1m to 50m* ³ (10% Reflectance Black paper 500mm×500mm) 0.1m to 120m* ⁴ (90% Reflectance white Kent paper1400mm×1400mm) Maximum area setting : 120m (Distance output range: 160m) Minimum detectable size Normal mode : 65mm(5m), 130mm(10m), 260mm(30m) High resolution mode : 33mm(5m), 65mm(10m),130mm(30m)
Average Accuracy by distance	10% Reflectance Black paper 0.1m to 30m : ±30mm (Indoor 1,000lx or less) 30m to 50m : ±40mm (Indoor 1,000lx or less) 0.1m to 50m : ±50mm* ⁵ (Outdoor 100,000lx or less) 90% Reflectance white Kent paper 0.1m to 50m : ±30mm 0.1m to 50m : ±50mm* ⁵ (Outdoor 100,000lx or less)
Measurement resolution	1mm
Repeat accuracy	10% Reflectance Black paper 0.1m to 30m : $\sigma < 9\text{mm}$ (Indoor 1,000lx or less) 30m to 50m : $\sigma < 15\text{mm}$ (Indoor 1,000lx or less) 0.1m to 50m : $\sigma < 15\text{mm}$ * ⁵ (Outdoor 100,000lx or less) 90% Reflectance white Kent paper 0.1m to 50m : $\sigma < 9\text{mm}$ (Indoor 1,000lx or less) 0.1m to 50m : $\sigma < 15\text{mm}$ * ⁵ (Outdoor 100,000lx or less)
Scanning angle	190°
Scan speed/ Angular resolution	20ms* ⁶ (Normal mode 3000rpm) / approx. 0.32° (360°/1125) 40ms* ⁶ (Low speed mode 1500rpm) / approx.0.16° (360°/2250) 80ms* ⁶ (High resolution mode 750rpm) / approx.0.08° (360°/4500)
Start up time	Within 30 sec after power supply
Outputs	4 NPN OUTPUT :Synchronization master output, Synchronization output, Malfunction output, Contamination output (Open collector output DC30V 50mA MAX.)
Output response time	40msec or less (Normal mode) 80msec or less (Low speed mode) 160msec or less (High resolution mode) In either case, change depending upon the delay setting
Inputs	3 INPUT : Synchronous input, IP Reset input, Reboot input (Photo coupler input, Anode common, Input ON current 2mA)
Interface	Ethernet 100BASE-TX (Auto-negotiation)
LED display	4 LEDs (Yellow Green, Orange, Blue, Red)

Title	UGM-50LXN Specification	Drawing. No.	C-42-04477	4/13
-------	-------------------------	-----------------	------------	------

Specification (Continued)

Ambient temperature and humidity	-10 to +50°C below 85%RH -30 to +50°C below 85%RH (While using the heater) (Without dew, frost)
Environment effect	A measured distance will be shorter than an actual distance under the influence of rain, snow and direct sunlight.*7
Vibration resistance	10 to 150Hz 5G IEC60068-2-6:2007
Shock resistance	3 times 50G, 1000 times 25G IEC60068-2-27:2008
EMC standards	(EMI) EN61326-1:2013 EN55011:2009 + A1:2010 (EMS) EN61326-1:2013 EN61000-4-2:2009 EN61000-4-3:2006 + A1:2008 + A2:2010 EN61000-4-4:2012 EN61000-4-6:2009 EN61000-4-8:2010
Protective structure	IP67 IEC60529:2001
Insulation resistance	10MΩ
Weight	Approx. 4.2kg (without connection cables)
Material	Optical window : Polycarbonate, Body : Aluminum
Dimensions(W×D×H)	155mm × 166mm × 176mm (Without connector) External dimension : MC40-03391

Notes

- *1 When a heater power is not connected or OFF.
- *2 This is the current consumption of only heater.
Details of heater operation is described in "7. Heater Function".
- *3 Indoor environment (under fluorescent lamps, 1,000 lx or less)
- *4 In the high resolution mode(750rpm), the guarantee detection range is 120m.
- *5 Detection cannot be guaranteed when direct light (such as sunlight) enters into the inside of the product.
- *6 You must restart the sensor after changing the scan speed.
- *7 Please check the influence of ambient environment on the detection accuracy using a product.

Title	UGM-50LXN Specification	Drawing. No.	C-42-04477	5/13
-------	-------------------------	-----------------	------------	------

4. Connection

4.1 Power supply connector

M12 4 core A-code socket (Female)

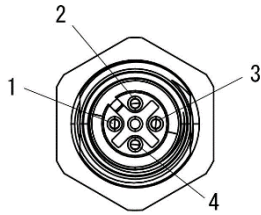

PIN No.	Function
1	Sensor power supply +V (24V±10%)
2	Sensor power supply GND -V (0V)
3	Heater power supply (24V±10%)
4	Heater power supply GND(0V)

4.2 Ethernet connector

M12 4 core D-code plug (Male)

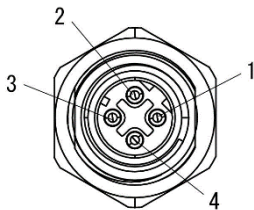

PIN No.	Function
1	TX+
2	RX+
3	TX-
4	RX-

4.3 I/O connector

I/O1 : M12 8 core A-code socket (Female)

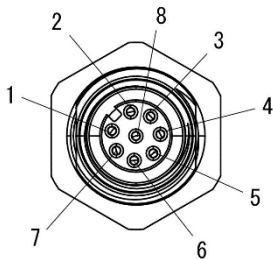

PIN No	Function	I/O
1	Reboot	IN
2	IP Reset	IN
3	Synchronization input	IN
4	Synchronization output	OUT
5	Synchronization master output	OUT
6	NC	-
7	+COM	-
8	-COM	-

I/O2 : M12 12 core A-code socket (Female)

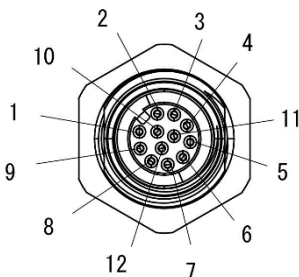

PIN No	Function	I/O
1	Contamination output	OUT
2	NC	-
3	Malfunction output	OUT
4	-	-
5	-	-
6	-	-
7	-	-
8	-	-
9	-	-
10	-	-
11	+COM	-
12	-COM	-

Title

UGM-50LXN Specification

Drawing.
No.

C-42-04477

6/13

4.4 Input/output circuit

Input: Photocoupler input (Anode common, 5mA during each input ON, 0.5 mA or below during OFF)

Output : Open-collector output

Item	Specification
Maximum output current	50mA
Maximum voltage	30V
Output residual voltage	2V or less
+COM Power supply range	24±10% V

Example of connecting the input/output circuit

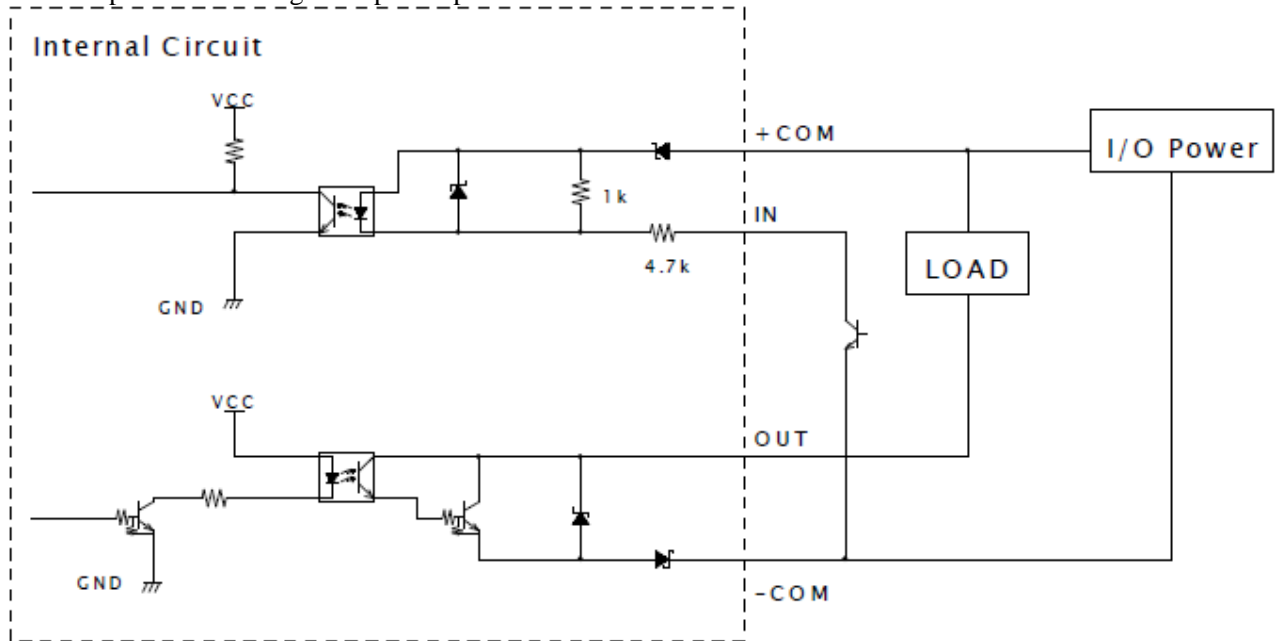

Connect both +COM and -COM to I/O Power.

Title	UGM-50LXN Specification	Drawing. No.	C-42-04477	7/13
-------	-------------------------	-----------------	------------	------

5. Control signal

5.1 Malfunction output

- (1) Laser malfunction : When laser emission is not possible or laser power have exceeded the safety class 1.
- (2) Motor malfunction : When motor rotation inside the sensor is unstable.

When a malfunction occurs, the UGM-50LXN switches the malfunction output to OFF (High level), and then stops laser emission and motor rotation.

You can check the error code using communication protocol SCIP. Refer to troubleshooting table in section 6 for error details.

5.2 Synchronization output

The UGM-50LXN outputs a pulse of 1ms every one scan for synchronized with the scanning.

The timing of the synchronization signal is shown in the figure below.

* Scan speed 20ms (In normal mode)

* Description based on scan speed 20 ms

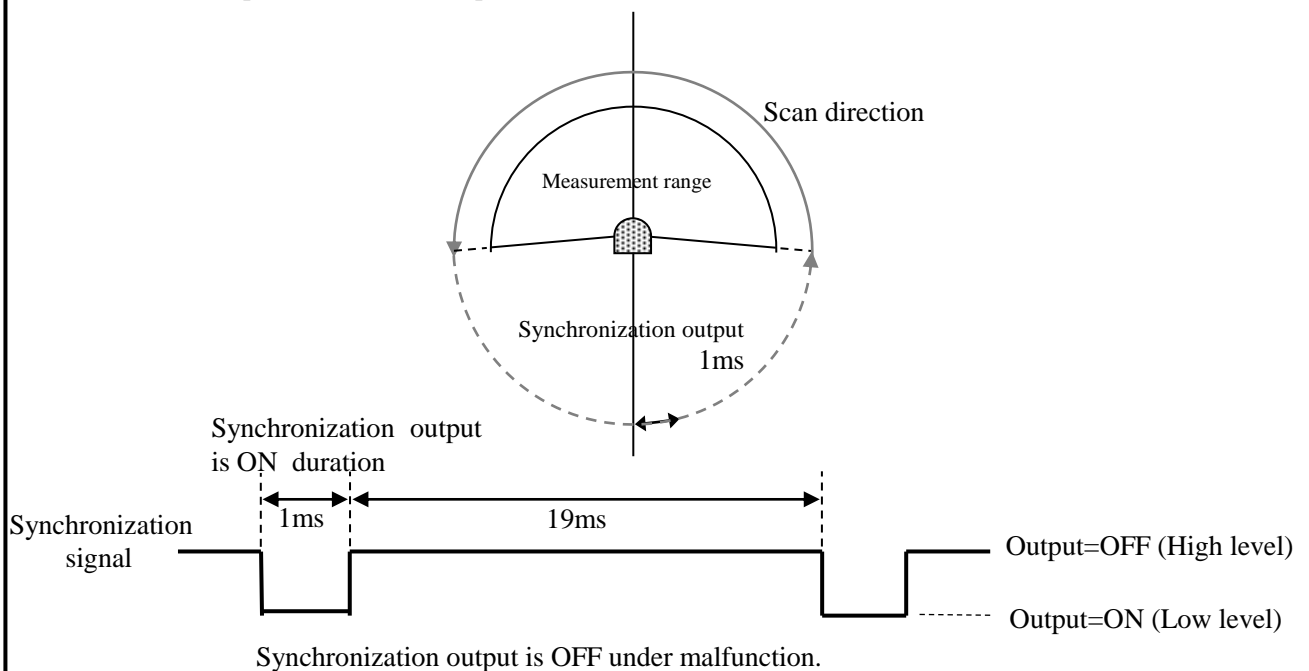

5.3 Synchronization master output

This is a reference clock signal for synchronizing motor rotation of each sensor.

The UGM-50LXN output the clock signal with cycle of 20ms and an output-OFF period (High level) of 5ms (Duty25%). Synchronization master output is continued even in the malfunction state.

Title	UGM-50LXN Specification	Drawing. No.	C-42-04477	8/13
-------	-------------------------	-----------------	------------	------

5.4 Synchronization input

In a multiple connection of UGM-50LXN, you can synchronize with motor rotation inside each sensor.

By connecting the synchronization input terminal of the slave to both synchronization master output terminal and the synchronization input terminal of the master, you can synchronize the motor rotation of the slave with the motor rotation of the master. Synchronization is performed on the falling edge of the clock signal.

5.5 Example of connection between multiple sensors for synchronization of motor rotation

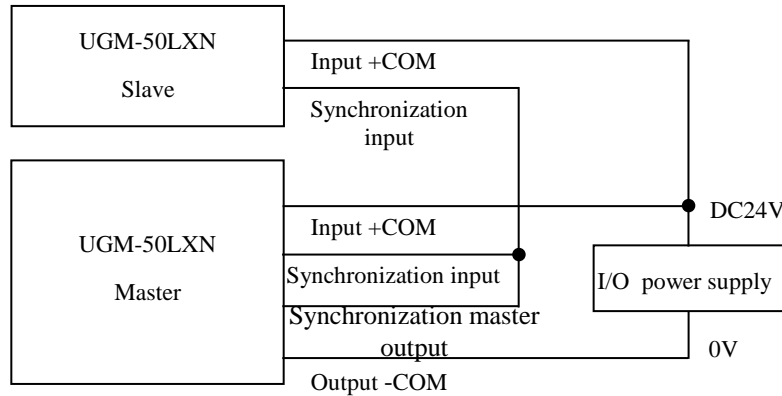

As shown in the figure above, it is possible to synchronize the motor rotation of the slave with the motor rotation of the master according with shifted the scanning time of each slave sensor by setting phases of each slave sensor.

You can confirm and configure phases using the application software.

5.6 Timing chart of synchronization input/output

- When the synchronization master output of the master is not connected to the synchronization input of the slave, the synchronization output terminals of both the master and the slave sensors continue to output pulse signals according with cycle of 20ms and low of 1ms.

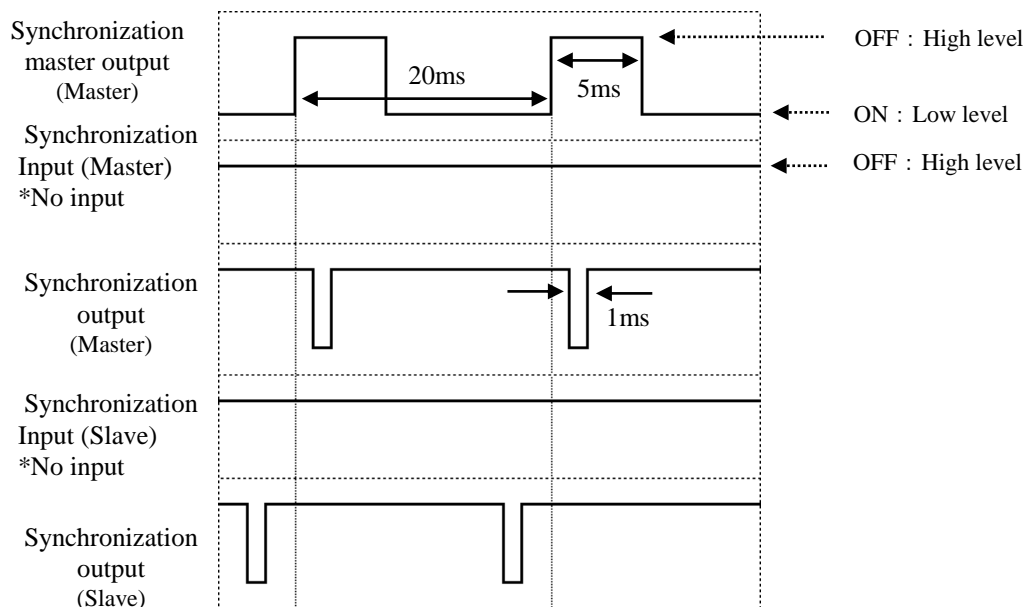

Title	UGM-50LXN Specification	Drawing. No.	C-42-04477	9/13
-------	-------------------------	-----------------	------------	------

When the synchronization master output of the master is connected to the synchronization input of the slave, the master sensor can synchronize falling edges of the synchronization master output signal with falling edges of the synchronization output signal.

When the phase value is set, the synchronization output with the phase shifted by the set value only. Error of phase setting should be within ± 1 ms.

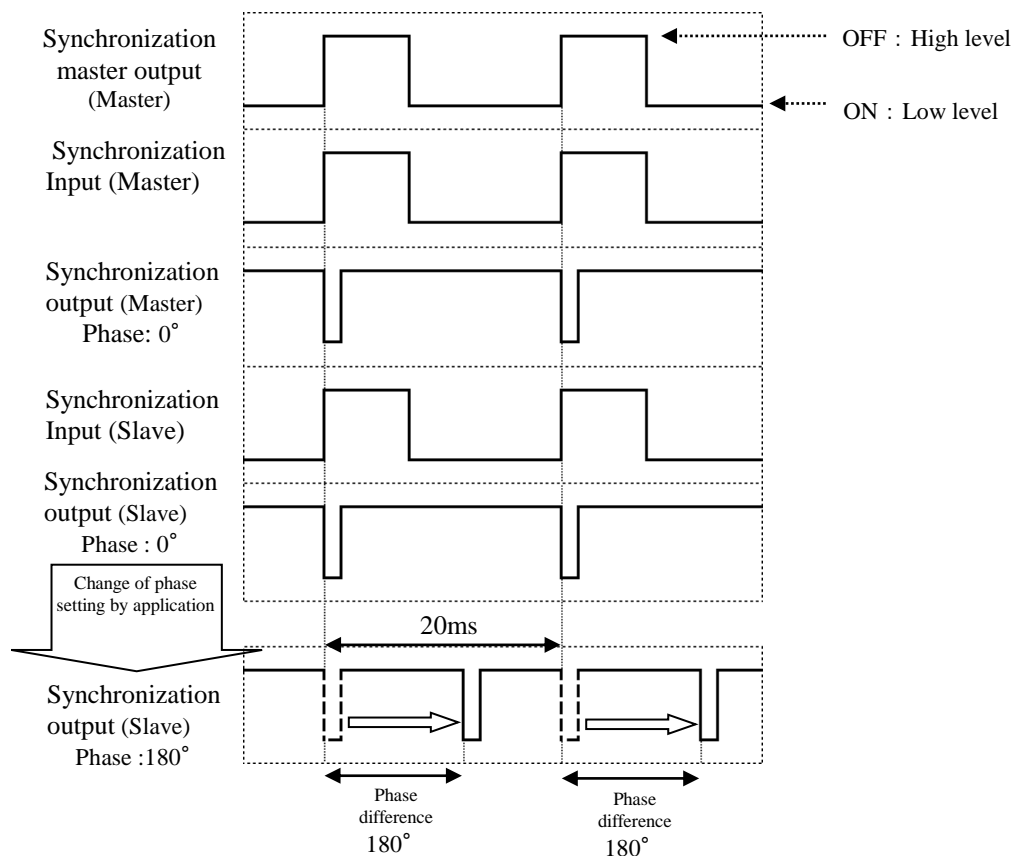

5.7 IP Reset input

Return the IP address to the initial value (192.168.0.10).

Switch to ON (Low level) for 2 seconds or more, then switch to OFF (High level) for IP address initialization.

Notes

Before you switch off the sensor power, you need to make sure that IP Reset input is in the High level. If you switch off the sensor while IP Reset input is in Low level, the sensor may not start normally after that.

5.8 Reboot input

When switching to ON (Low level) for 2 seconds or more, you can restart the sensor operation.

5.9 Contamination output

When detecting dirt on the optical window (contamination detection) : ON (Low level)

When no detecting dirt on the optical window (No contamination detection) : OFF (High level)

Title	UGM-50LXN Specification	Drawing. No.	C-42-04477	10/13
-------	-------------------------	-----------------	------------	-------

6. Troubleshooting

6.1 Error code table

You can obtain the causes of errors from STAT line of the “II” command response in the communication protocol SCIP. The error codes and solutions from the STAT line are as follows in table.

ID	Message	Meaning	solution
000	no error.	Normal operation	No action is required.
051	internal setup failed.	Sensor processing system error	Sensor has failed and needs to be repaired.
052	internal chip access failed.	Same as above	
100			
200	encoder error.	Encoder error	
201			
250	motor startup failed.	Motor error	
251	motor rotation error.	Unstable motor rotation	Reduce the vibration and noise to the sensor
300	laser too high.	Laser error	Reduce the ambient light and noise to the sensor
301	laser too low.	Same as above	
302	laser no echo.	Same as above	

6.2 About distance values

x	Meaning	
$35 \leq x \leq 160,000$	Distance values	Measured distance values (mm)
x = 262,140 (3FFFC)	No echo	When no object is detected, or the detected level inside the product is below a threshold value. (the value of light receiving shows 0)
x = 262,142 (3FFFE)	Short distance error	When a distance from this product to object is 34 mm or below.
x = 262,143 (3FFFF)	Long distance error	When a detected object is at the location of 160,001 mm or above.

Title	UGM-50LXN Specification	Drawing. No.	C-42-04477	11/13
-------	-------------------------	-----------------	------------	-------

6.3 Relation between product states and LED displays

Product states	LED			
	Yellow green (Power)	Orange (Heater)	Blue (Detection)	Red (Malfunction)
During start up	ON	ON when heater is activated.	Blinks (2sec. intervals)	OFF
During operation	ON	ON when heater is activated.	ON when an object is detected.	OFF
During Malfunction	ON	OFF	OFF	OFF
During Motor stop (sleep)	ON	ON when heater is activated.	Blinks (4sec. intervals)	OFF
During contamination detection	Same as operation			
IP initialization	ON	ON when heater is activated.	Blinks (1sec. interval)	Blinks (1sec. interval)

6.4 Relation between product states and output signals

Product states	Synchronization master output	Synchronization output	Contamination detection	Malfunction output
During start up	Continuous output after power supply is ON.	Tr=OFF(High)	Tr=ON(Low)	Tr=ON(Low)
During operation		1 ms per cycle Tr=ON(Low)	Tr=OFF(High)	Tr=ON(Low)
During Malfunction		Tr=OFF(High)	Tr=OFF(High)	Tr=OFF(High)
During Motor stop (sleep)		Tr=OFF(High)	Tr=OFF(High)	Tr=ON(Low)
During contamination detection		Same as operation	Tr=ON(Low)	Tr=ON(Low)
IP initialization		Tr=OFF(High)	Tr=OFF(High)	Tr=OFF(High)

* Output signals will be undefined immediately after power-ON. The undefined time depends on a motor speed(scan speed).

* From IP initialization completion to restart, output signals will be undefined.

7. Multi-echo function

This product has the multi-echo function. In the same step, the function obtained distances and values of light receiving is called the multi-echo.

This product can receive of up to 4 echoes (the 1st. echo, the 2nd. echo, the 3rd. echo, and the last echo) per step, and can acquire distances and values of light receiving on each step.

If laser light emitting from this product reflects such as transparent objects, rain, fog, dust, and

Title	UGM-50LXN Specification	Drawing. No.	C-42-04477	12/13
-------	-------------------------	-----------------	------------	-------

boundary between objects, this product can receive both echoes from those objects and echoes from other objects ahead of those objects.

However, when distances between objects are too close or reflectance of objects is low, this product may not detect echoes.

8. Heater function

This product has a heater inside the product to prevent dew condensation on the optical window. You can select either “Active” or “Inactive” using the application software. The initial operation mode of the heater function is Inactive.

When the heater function is activated, the heater will operate if the temperature inside the product decreases below 0°C.

When the temperature inside the product increases more than 10°C, the heater will stop its operation automatically.

9. Optical window contamination warning function

This function is enabled “Active” using the application software. When this function is enabled “Active”, contamination output will switch to ON Δ if the optical window is contaminated above certain level. The UGM-50LXN will continue to operate and there will be no malfunction stop.

10. Ethernet setting

10.1 Default value

IP default value : 192.168.0.10

Port number : 10940

10.2 About changing IP address

You can change IP address using a dedicated application software.

10.3 IP address initialization

Switch IP reset input to ON (Low) for 2 seconds or more, then switch to OFF (High).

Title	UGM-50LXN Specification	Drawing. No.	C-42-04477	13/13
-------	-------------------------	-----------------	------------	-------