

# 2D LiDAR

## UGM-50LXP UGM-50LAP

### User's Manual

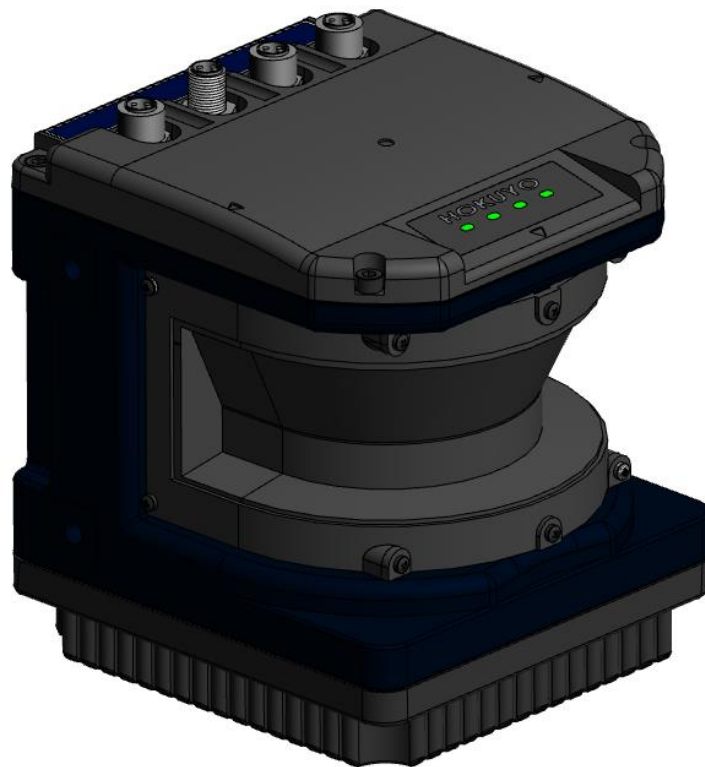

## Table of contents

<b>1. Introduction</b> .....	<b>4</b>
<b>1.1 About this document/manual</b> .....	<b>4</b>
<b>1.2 Applicable product</b> .....	<b>4</b>
<b>1.3 Special markings and symbols</b> .....	<b>4</b>
<b>1.4 Cautions</b> .....	<b>5</b>
<b>1.5 Registered trademarks</b> .....	<b>5</b>
<b>2. Safety precautions</b> .....	<b>6</b>
<b>2.1 General precautions</b> .....	<b>6</b>
<b>2.2 Operating environment</b> .....	<b>6</b>
<b>2.3 Installation of UGM</b> .....	<b>6</b>
<b>2.4 Wiring</b> .....	<b>7</b>
<b>2.5 Inspection and maintenance</b> .....	<b>7</b>
<b>3. Product overview</b> .....	<b>8</b>
<b>3.1 Features of UGM-50LAP</b> .....	<b>8</b>
<b>3.2 UGM-50LAP components</b> .....	<b>9</b>
<b>3.3 Operation principle</b> .....	<b>11</b>
<b>3.4 Area configuration</b> .....	<b>12</b>
<b>3.5 Area switching</b> .....	<b>14</b>
<b>3.6 Detection condition</b> .....	<b>15</b>
<b>3.7 ON delay/OFF delay</b> .....	<b>16</b>
<b>3.8 Hysteresis of detection area</b> .....	<b>18</b>
<b>3.9 Optical window contamination detection function</b> .....	<b>19</b>
<b>3.9.1 Contamination detection (Partial)</b> .....	<b>19</b>
<b>3.9.2 Contamination detection (All)</b> .....	<b>19</b>
<b>3.10 Setting of UGM</b> .....	<b>20</b>
<b>3.11 Output</b> .....	<b>23</b>
<b>3.11.1 Detection Output 1 to Output 3</b> .....	<b>23</b>
<b>3.11.2 Malfunction output</b> .....	<b>23</b>
<b>3.11.3 Contamination output</b> .....	<b>23</b>
<b>3.11.4 Synchronous output</b> .....	<b>23</b>
<b>3.11.5 Synchronous master output</b> .....	<b>24</b>
<b>3.12 Input</b> .....	<b>24</b>
<b>3.12.1 Area Input 1 to Input 4</b> .....	<b>24</b>
<b>3.12.2 Synchronous Input</b> .....	<b>24</b>
<b>3.12.3 Reboot input</b> .....	<b>25</b>
<b>3.12.4 IP reset input</b> .....	<b>25</b>
<b>3.13 Indicator lamp</b> .....	<b>25</b>



---

3.14 Heater function .....	25
4. Installation .....	27
4.1 Caution for installation .....	27
4.2 Optical axis adjustment .....	28
4.3 Light interference .....	28
4.4 Contamination on the optical window .....	29
4.5 Mutual intreferece .....	30
4.6 Synchronous operation .....	32
5. Wiring.....	35
5.1 Precautions.....	35
5.2 Power supply.....	35
5.3 Pin assignments and function .....	36
5.4 Input/Output circuit.....	37
5.4.1 Input circuit .....	37
5.4.2 Output circuit.....	37
5.5 Interface connector .....	38
5.5.1 Power supply I/O connector .....	38
5.5.2 Ethernet connector .....	39
5.5.3 I/O1 Connector (8pin) .....	40
5.5.4 I/O2 Connector (12pin) .....	41
6. Setting of Area Designer .....	43
6.1 Area Designer.....	43
6.2 System requirements .....	43
7. Communication .....	44
7.1 Ethernet setting.....	44
7.1.1 Initial value.....	44
7.1.2 Changing IP address.....	44
7.2 Communication protocol .....	45
7.3 Error code table .....	45
7.4 Detail on measurement values .....	46
8. Inspection and maintenance .....	47
8.1 Pre-operation inspection .....	48
8.2 Operation inspection .....	48
8.3 Daily inspection.....	49
8.4 Periodical inspection .....	50
8.5 Cleaning the optical window.....	51
9. Troubleshooting .....	52
10. Specification.....	53



---

<b>11. Applicable directives and standards .....</b>	<b>55</b>
<b>12. Package contents .....</b>	<b>56</b>
<b>13. Options .....</b>	<b>57</b>
<b>13.1 Power supply I/O connection.....</b>	<b>57</b>
<b>13.2 Ethernet connection .....</b>	<b>57</b>
<b>13.3 I/O1 (8pin) connection.....</b>	<b>57</b>
<b>13.4 I/O2 (12pin) connection.....</b>	<b>57</b>
<b>13.5 Mounting bracket.....</b>	<b>57</b>
<b>14. External dimension.....</b>	<b>58</b>
<b>14.1 UGM-50LAP, UGM-50LXP .....</b>	<b>58</b>
<b>14.2 Base mounting bracket.....</b>	<b>59</b>
<b>14.3 Rear mounting bracket .....</b>	<b>60</b>
<b>15. Revision history .....</b>	<b>61</b>



# 1. Introduction

This user's manual is designed with the purpose of providing guidelines and instructions for machine users or system designers while operating, installing, wiring and servicing the UGM-50LAP (Below UGM) sensor.

## 1.1 About this document/manual

The UGM's features, installation and handling method are described in this document.

- Make sure that you read carefully and understand this document before installation, wiring, operation, inspection and maintenance.
- User should have a copy of this document at an easy-to-access place for quick reference.
- Any modifications or disassembly of the UGM is prohibited. Modifications will affect sensor performance and detection capability that could lead to critical injury and death.
- Any modifications or disassembly of the UGM will void the warranty.
- All information in this user's manual is subject to change without prior notice. For the latest information visit our company's website at <http://www.hokuyo-aut.jp>



## 1.2 Applicable product

This document is for the following sensor model.

- UGM-50LAP/ LXP

## 1.3 Special markings and symbols

Markings and symbols are used in this document to alert the user about safety-related issues. Follow the instructions of these special markings and symbols to ensure safety during the operation.

Mark	Meaning
 <b>Danger</b>	Procedures that could lead to dangerous situation, critical injury or death if not carried out properly.
 <b>Caution</b>	Procedures that could lead to dangerous situation, serious injury or physical damage if not carried out properly.
<b>Note</b>	Points that should be considered for the proper operation.



## 1.4 Cautions

- The UGM has been shipped upon strict quality control. If you find any defect in the product, contact the nearest distributor or sales representative.
- Hokuyo cannot be held responsible for damages or failure due to misuse of the UGM.
- The actual product may differ from the illustrations and figures in this document as they are used for explanatory purpose only.

## 1.5 Registered trademarks

- Microsoft<sup>®</sup>, Windows<sup>®</sup> are the registered trademarks of Microsoft Corporation USA.
- Pentium<sup>®</sup> are the registered trademarks of Intel Corporation or respective country.
- Beside that, other product names, company name mentioned are trademarks or registered trademarks of their respective companies.



## 2. Safety precautions

Make sure that you read the following safety precautions for the correct use and operation of the UGM.

### 2.1 General precautions

- The UGM uses laser radiation for detecting objects.
- Perform pre-operation tests in order to verify the performance of the UGM.
- Operate the UGM within the specifications described in this user's manual. Also, perform the necessary maintenance to prevent deterioration of UGM's detection capability. (Refer to chapter 8)
- Do not modify or disassemble the UGM. This could compromise the IP67 housing rating. Such modifications will void the warranty.
- The UGM is not a safety device. Do not use this sensor for the purpose of protecting humans.
- The detection capability of the UGM will decrease if dust covers with the optical window. Regular cleaning of the optical window is necessary while working under dusty environment.(Refer to section 8.5)
- The UGM should be disposed as industrial waste or in accordance with the local disposal directives.

### 2.2 Operating environment

- Make sure that the UGM's operating environment is within the stated specification (temperature, humidity, vibration, ambient light, etc.)
- Do not use or mount the UGM near devices that could generate strong electromagnetic waves as it could affect the operation of the sensor.
- Do not use or mount the UGM in an environment of organic solvents, gas, or where corrosive substances are present. Working under such environments may decrease the detection capabilities of the sensor.

### 2.3 Installation of UGM

- Install the UGM on a firm surface or structure to avoid displacement.
- Do not install the UGM in a place that is subject to shock or vibration that is out of specification.
- Shock and vibration should not loosen the mounting. If UGM is displaced, the intended detection may not be possible.
- Mutual interference can occur when two or more UGM sensors are mounted at the same detection plane. Refer to chapter 4 (mutual interference and synchronous operation) for details.
- When using UGM outdoors, you need to add necessary measures to prevent from rain and/or dust accumulation on the optical window.
- The UGM should be mounted with a provision of sufficient space for maintenance.
- Do not put any object in the detection area of the UGM. It is not possible for the sensor to detect objects that lie behind the obstacle.
- Increasing the response time will also increase the stability of the UGM. However, this will reduce the



---

detection capability towards moving objects. User must perform pre-operation tests before using this function.

- Due to high speed internal processing UGM generates too much heat. The generation heat is concentrated at the case, therefore it is recommend to mount on a metal case.
- There is a ventilation window on the bottom of the UGM to keep the outside temperature and the temperature inside the UGM constant. Do not block the ventilation window with tape.

## 2.4 Wiring

- Switch off all the power supplies during wiring.
- When a converter is used for supplying the power, make sure that it fulfills the following requirements.
  - A rated output voltage within the range of DC 24V±10%
  - Use power source with 3.5A or more (During DC 24V) current capacity.
  - The power supply complies with the requirements of electromagnetic compatibility regulations (EMC) of the respective country, states and district.
- All the input/output signal cables should be installed away from machine's power lines and high- voltage cables.

## 2.5 Inspection and maintenance

- User must perform inspection and maintenance by referring to the following checklists provided in this document. (Refer to chapter 8)
  - Pre-operation inspection
  - Operation inspection
  - Daily inspection
  - Periodical inspection
  - Cleaning the optical window

Checklists in this document are provided as the basic guidelines while performing the test and maintenance. User must perform additional inspection and maintenance tasks deemed necessary for the respective application.

- Stop the machine and system if faults are detected during these tests.
- Clean the optical window when it gets contaminated. If the optical window is damaged, it should be replaced by a new one, therefore contact the nearest distributor or sales representative.



### 3. Product overview

The UGM scans a semicircular field using a laser beam ( $\lambda=905\text{ nm}$ ), then calculates coordinates by measuring the distance from an object and its step angle (LXP type) and detects obstacles within the setting area (LAP type). Only LXP type supports the multi echo data output. In LAP type, it is possible to output data of selected single echo.

This chapter describes the features and properties of the UGM-50LAP.

#### 3.1 Features of UGM-50LAP

- Detection range : Maximum 160m  
(Guarantee detection range: 0.1 to 120m 90% Reflectance white Kent paper 1400mm×1400mm)  
(Guarantee detection range: 0.1 to 50m 10% Black paper 500mm×500mm)
- Detection angle : 190°
- Angular resolution : 0.32°/0.16°/0.08°
- Maximum 15 set of areas (Configurable)
- Hysteresis of detection area (☞ 18 page)
- It is possible to configure area with its origin offset from the center of scanning laser beam.
- Easy configuration using PC installed with configuration application (Area Designer)  
For details refer to Area Designer user's manual (C-41-02621).
- Teaching function.
- Minimum response time of 50ms (Configurable)
- Malfunction output: Output of the self-diagnosis function.
- ON/OFF delay function (☞ 16 page)
- Optical window contamination detection function (☞ 19 page)
- Filter function (☞ 21 page)
- Limited detection capacity zone for short distance (☞ 22 page)
- Minimum detection width (☞ 22 page)
- Synchronization function: master/slave configuration is possible (☞ 32 page)
- SCIP communication protocol
- The communication protocol is compatible with SCIP2.2.  
For details refer to the communication specification (C-42-04403).  
(Only in LX type supports Multi echo commands)



- This product is an auxiliary safeguard product only. It is not a safety device. In the event of a product malfunction, it could cause a serious accident so use an additional safeguarding device such as bumpers. Also, take necessary measures such as backup circuit etc.



### 3.2 UGM-50LAP components

Figure 3-1 shows the components of UGM-50LAP.

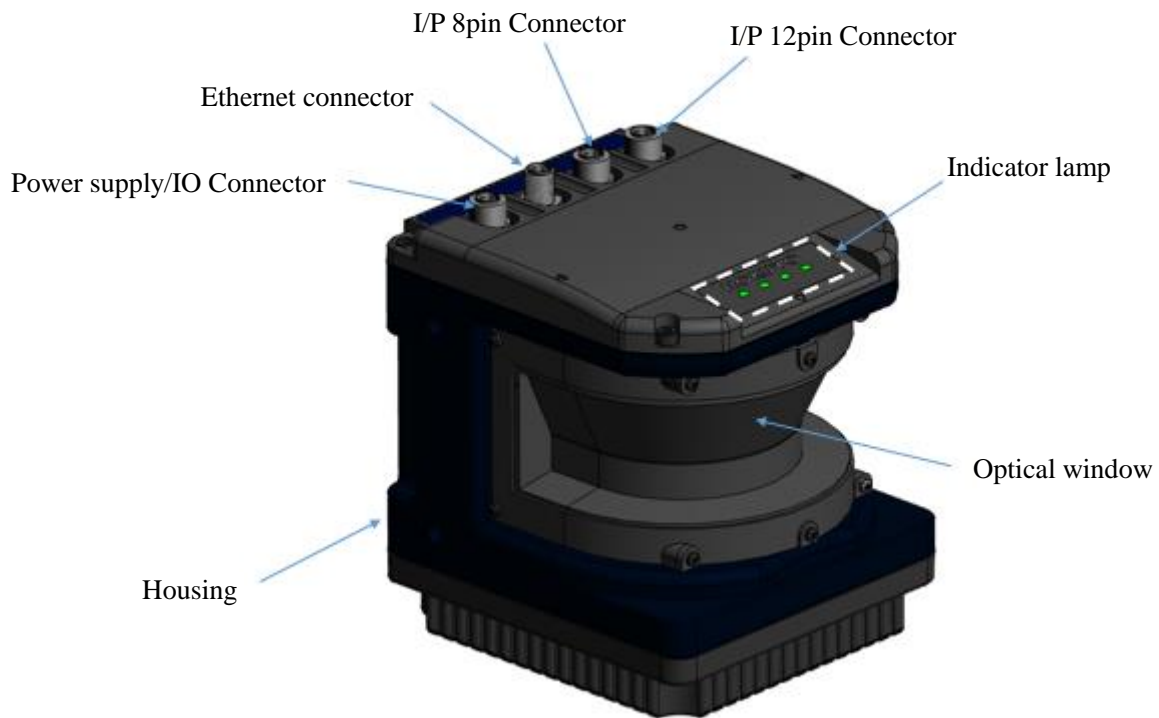

Figure 3-1 UGM-50LAP components

Figure 3-2 shows the scanning range and detection zone origin of the UGM, and figure 3-3 shows its detection plane.

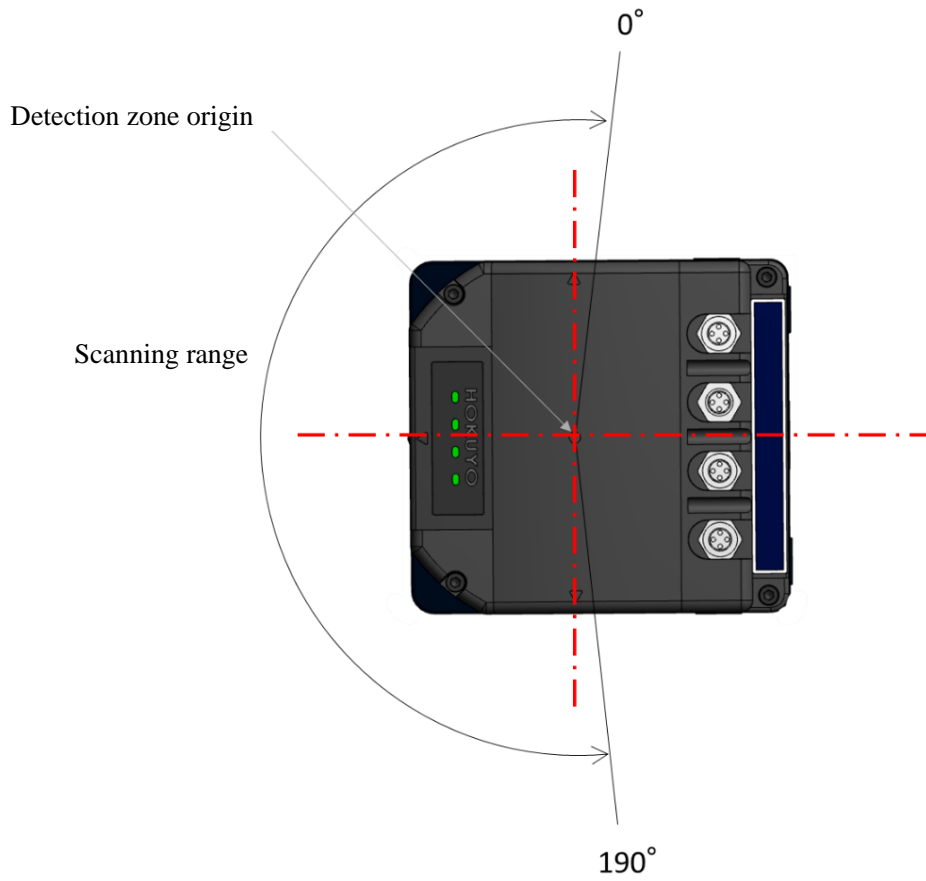

Figure 3-2 Scanning range and detection zone origin (Top view)

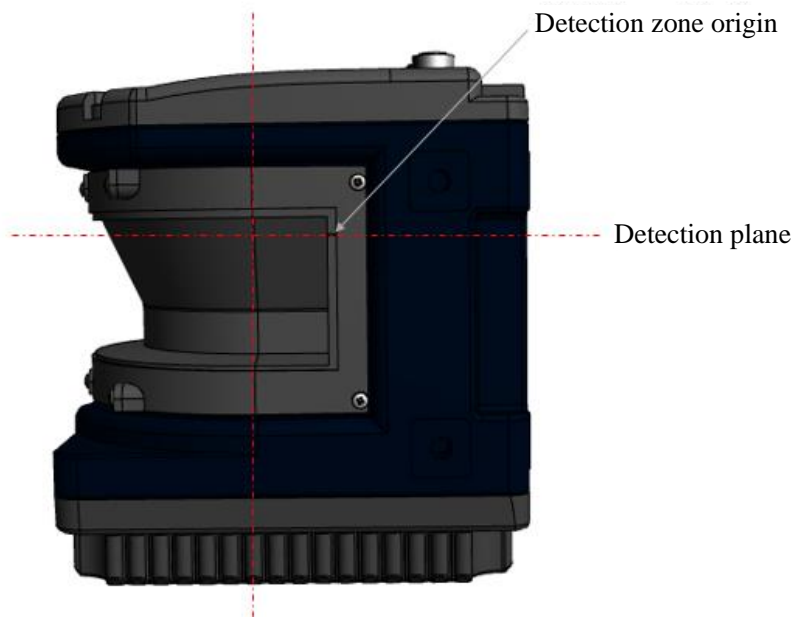

Figure 3-3 Detection plane of UGM (Side view)

### 3.3 Operation principle

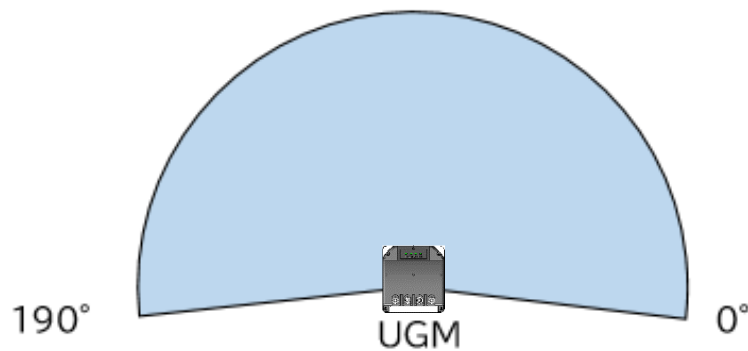

Figure 3-4 Scanning range

Figure 3-4 shows the scanning range of the UGM. The sensor emits pulsed laser beam which reflect on a rotating mirror forming a fan-like scanning pattern 190° field. Maximum detection range is 120m for white Kent paper. Detection range for objects of 10% diffused reflectance is 50m.

When the emitted laser beams are reflected back from an object, its distance is measured by applying the Time-of-Flight (TOF) principle. The duration of the reflected pulsed laser beam is taken for distance calculation as shown below.

$$L = \frac{1}{2} \times C \times T$$

Where, L=Distance of the object  
C=Speed of the light  
T=Time difference

The operation principle of TOF is shown in schematic diagram (Figure 3-5) below.

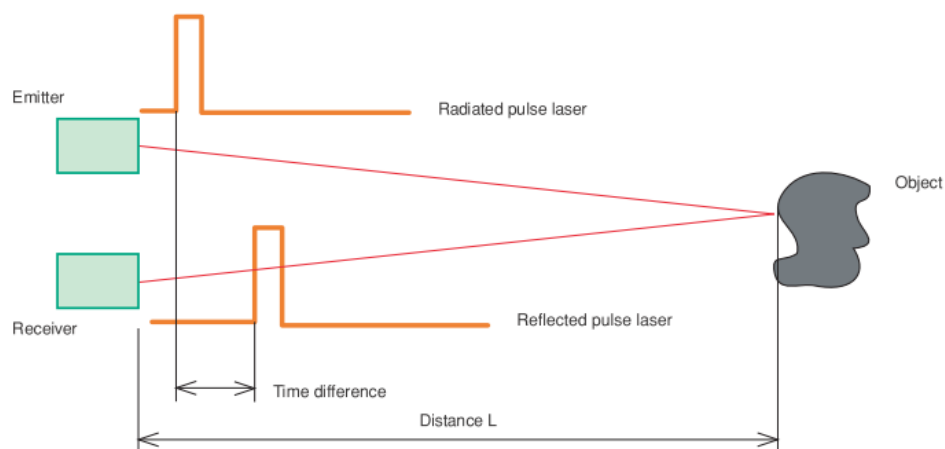

Figure 3-5 TOF operation principle

### 3.4 Area configuration

The UGM-50LAP can use area detection function. Output region 1 to output region 3 can be configured by using the Area Designer application software through an Ethernet cable. When an object enters into configured area, each detection output switches from ON to OFF state.

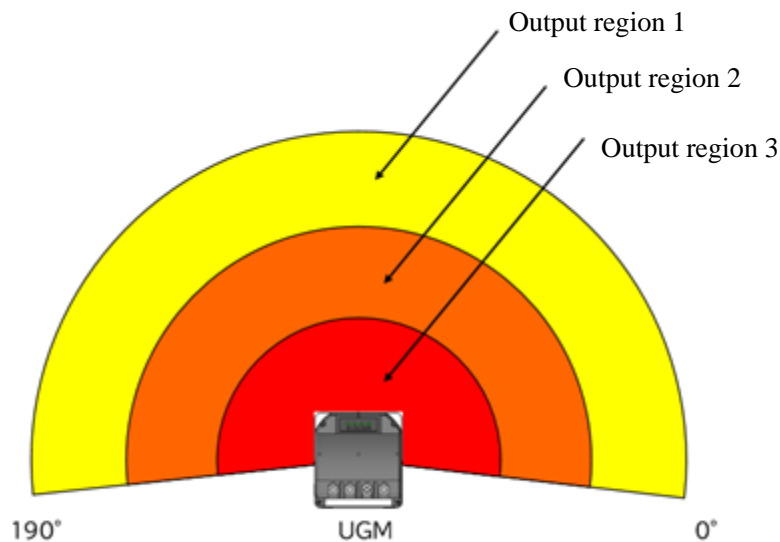

Figure 3-6 Detection area

The possible detection area types of UGM are shown in figure 3-6. The detection area of the UGM consists of output regions: Output 1, 2 and 3 respectively.

Area configuration methods can be Independent and Dependent. Maximum 15 set of areas can be configured. The area setting interval is 3 mm, therefore all entered values will be multiples of 3. (Example 101mm → 102 mm)

For independent method, the following shapes (polygon, arc and rectangle) can be set.

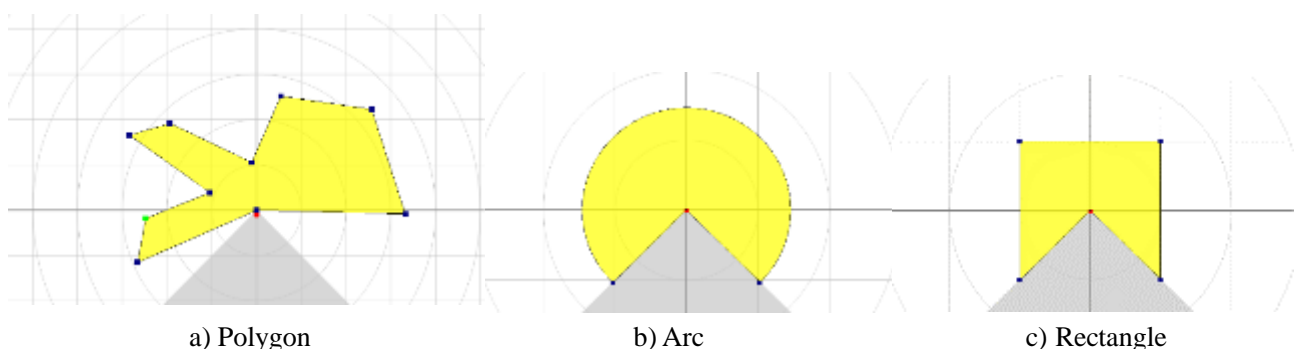

Figure 3-7 Area configurations (Independent method)

For the Dependent method, the following shapes are defined: Straight line, Fan, and Ratio. In the dependent method, output 1 serves as a basis for output 2. Similarly, output 2 can be set as the basis for output 3.

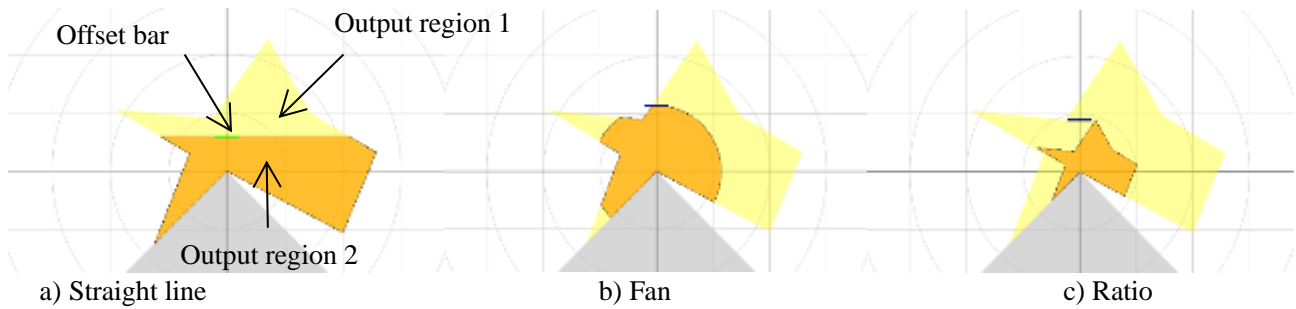

Figure 3-8 Area configurations (Dependent method)

When setting the output region 2 as dependent on output region 1, the following dependent methods can be selected: a) Straight line, b) Fan shape, c) Ratio. By moving the offset bar in the Y-axis, it changes the size of output region 2. The output 2 cannot be made larger than the output 1. Similarly, the output region 3 is used as a basis output region 2.

For details on area configuration methods, refer to the Area Designer sensor configuration tool Instruction manual. (C-41-02621)

When the sensor detects an object in the configured output region 1 to output region 3, the corresponding outputs signals are switched to OFF state and the corresponding LEDs are also lit.

**Danger**

- User should prepare test pieces for detection capability verification test.

### 3.5 Area switching

A maximum of 15 set of areas can be configured. For area switching, input signals 1 to 4 are required. Table 3-1 below shows the combination of input signal to switch the area. Laser is switched off when all the area inputs 1 to 4 are switched ON.

#### Note

- Laser emission is active only in the field of view of the selected area.
- If the selected area has no configuration, the detection output will be in the detection state.

Table 3-1 Input states and corresponding area number

Area Number	UGM-50LAP			
	Area Input 1	Area Input 2	Area Input 3	Area Input 4
Laser off	ON	ON	ON	ON
Area 1	OFF	ON	ON	ON
Area 2	ON	OFF	ON	ON
Area 3	OFF	OFF	ON	ON
Area 4	ON	ON	OFF	OFF
Area 5	OFF	ON	OFF	ON
Area 6	ON	OFF	OFF	ON
Area 7	OFF	OFF	OFF	ON
Area 8	ON	ON	ON	OFF
Area 9	OFF	ON	ON	OFF
Area 10	ON	OFF	ON	OFF
Area 11	OFF	OFF	ON	OFF
Area 12	ON	ON	OFF	OFF
Area 13	OFF	OFF	OFF	OFF
Area 14	OFF	OFF	OFF	OFF
Area 15	OFF	OFF	OFF	OFF

OFF: Low level, ON: High level,

Response time: 2 Scan

(Normal mode: 40ms / Low speed mode: 80ms / High resolution mode: 160ms)



### 3.6 Detection condition

In the configured area, if the detectable size (width) is more than the minimum detectable size, an output signal is triggered (for setting refer to section 3.10). The width of detectable object can be calculated as shown in figure 3-9.

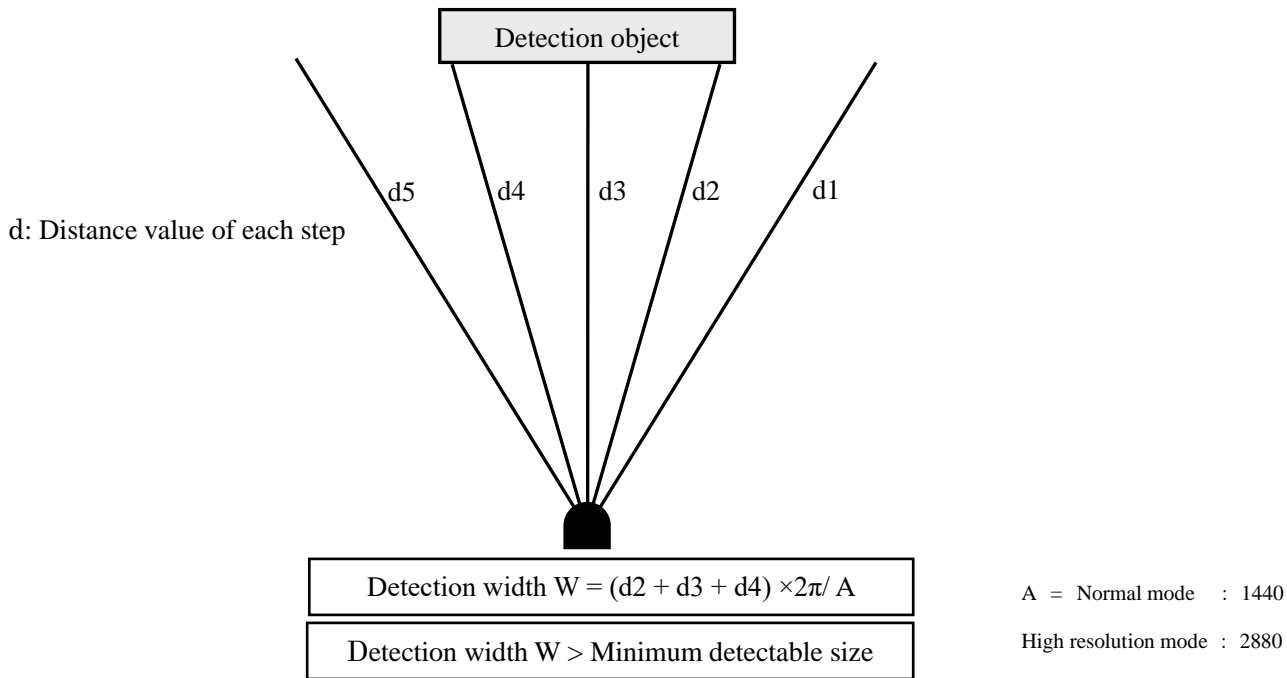

Figure 3-9 Schematic diagrams for the calculation of detection width

If the area is configured with a narrow width below the minimum detectable size, be careful that the output signal may not be triggered for a short distance as shown in figure 3-10

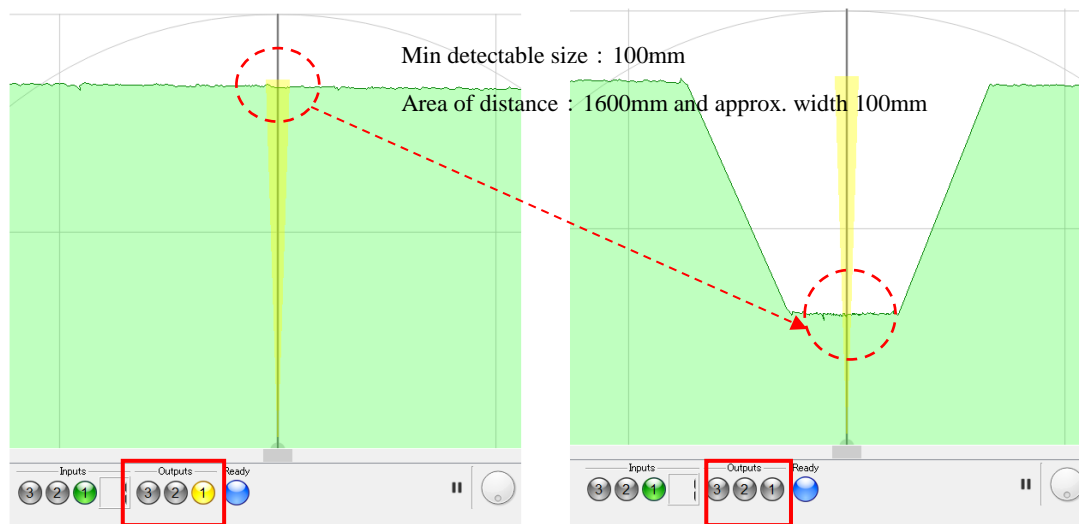

Figure 3-10 Caution when configuring area in the minimum detectable size.



#### Caution

- Depending upon the laser spot, environment and the detection object, the actual width of detected objects may differ from the measured width.
- User should verify the detection capability of the actual object before using in the target environment.



### 3.7 ON /OFF delay

ON delay and OFF delay of the detection output can be set within the range of 1 to 128 scans using Area Designer. (Default is 1 scan).

The time for one scan depends on the motor speed / angle resolution setting in the sensor settings.

- During Normal mode            3000rpm / 0.32° : 1scan / 20msec
- During Low speed mode        1500rpm / 0.16° : 1scan / 40msec
- During High resolution mode   750rpm / 0.08° : 1scan / 80msec

ON delay is the response time when the output is changing from ON state to OFF state after detecting an object.

OFF delay is the response time when the output is changing from OFF state to ON state after the object is absent in the detection area.

Increasing the response time will increase the stability of the outputs. However, this will reduce the detection capability towards moving objects. User must perform verification tests before using ON/OFF delay function.

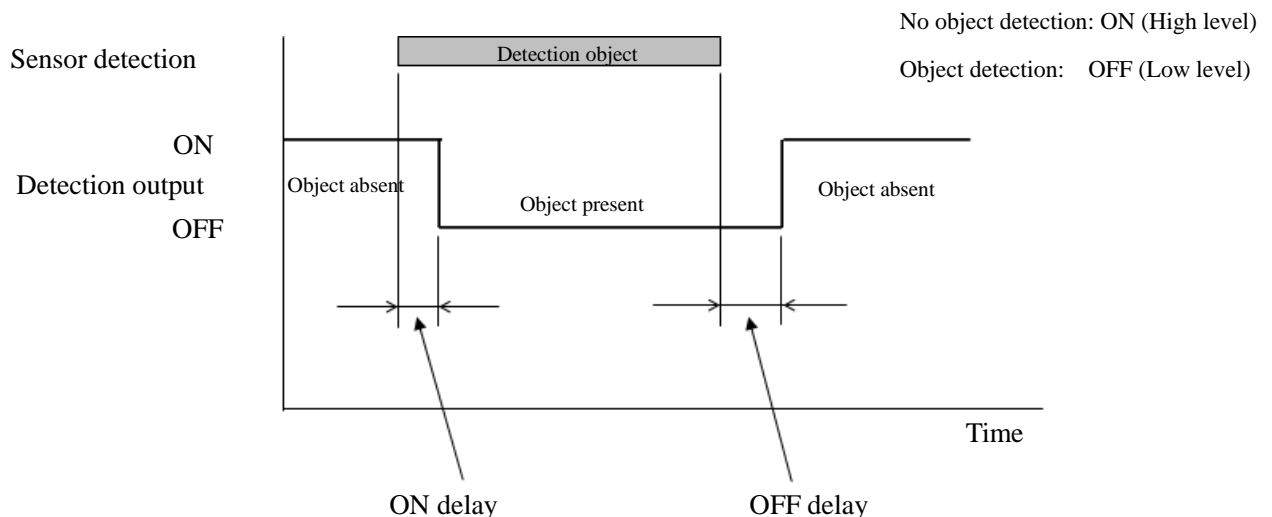
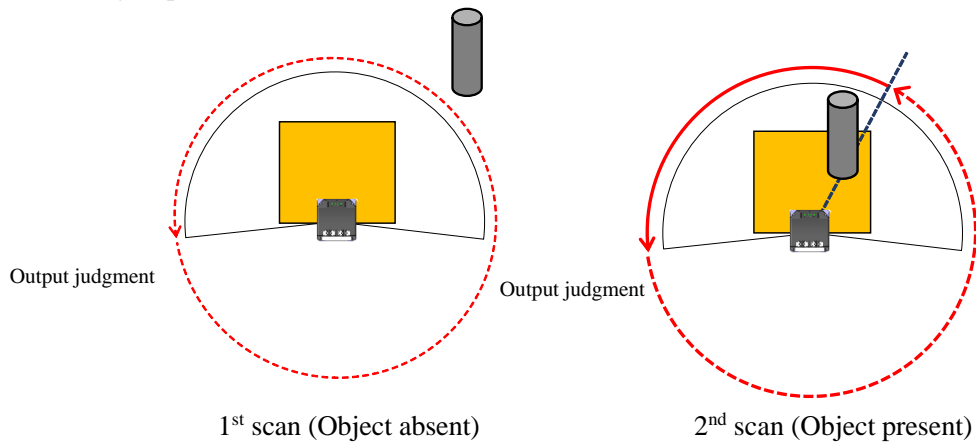

Figure 3-11 ON delay /OFF delay

Schematic diagram for ON delay/OFF delay operation is as shown below.

1. Example of schematic diagram without ON delay setting

- ←..... : Object absent
- ← : Object present



2. Example of schematic diagram when 2 scan ON delay setting

- ←..... : Object absent
- ← : Object present

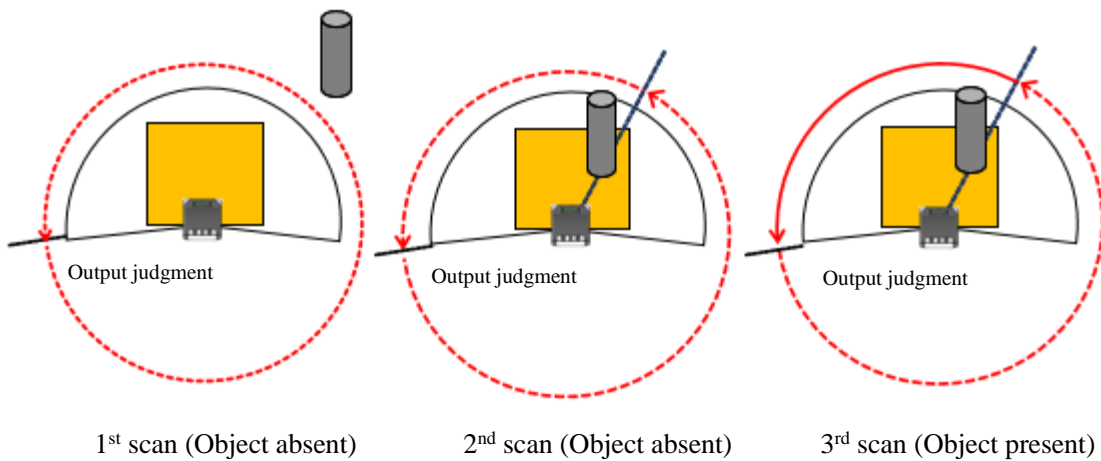

3. Example of schematic diagram without ON delay setting

- ←..... : Object absent
- ← : Object present

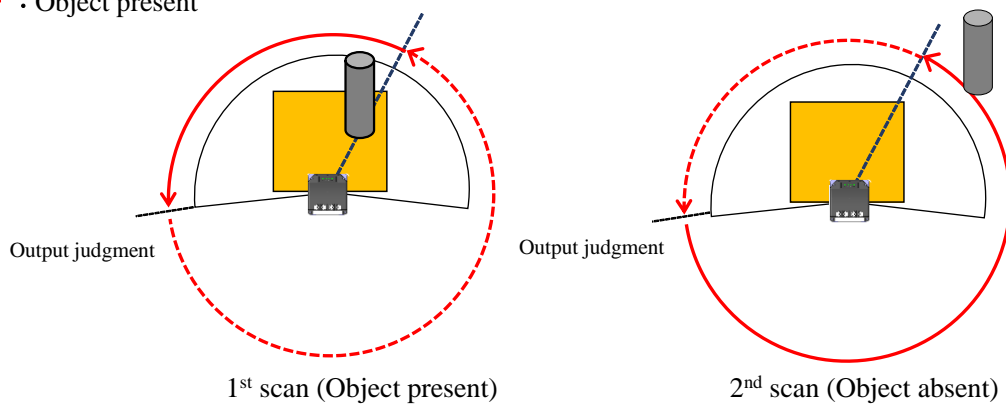

4. Example of schematic diagram when 2 scan OFF delay setting

←..... : Object absent

← : Object present

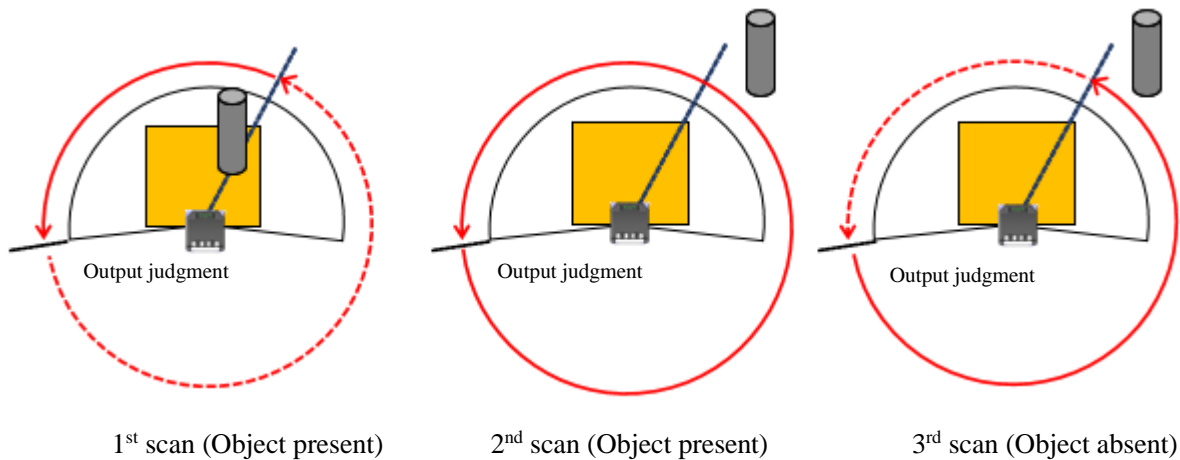

**3.8 Hysteresis of detection area**

When a sensor detects an object near the boundary of the detection area, outputs 1 to 3 may oscillate (Changing of ON/OFF state) repeatedly. To prevent such oscillation, sensor has a hysteresis function that temporarily increases the area size. If the object is not detected within the temporarily increased detection area then the detection area will return to its original state.

Hysteresis changes according to the set detection area distance. The minimum and the maximum temporarily increased detection area size can be specified using Area Designer configuration application. Minimum detection value will be used if the value is 5000mm or less. Also, maximum detection value will be used if the value is 30000mm or more. For distances between 5000mm to 30000mm; the value is computed using the linear interpolation method from the minimum and maximum values.

$$\text{Hysteresis} = (\text{Max value} - \text{Min value}) / (25000) \times \text{Distance} + (6 \times \text{Min value} - \text{Max value}) / 5$$

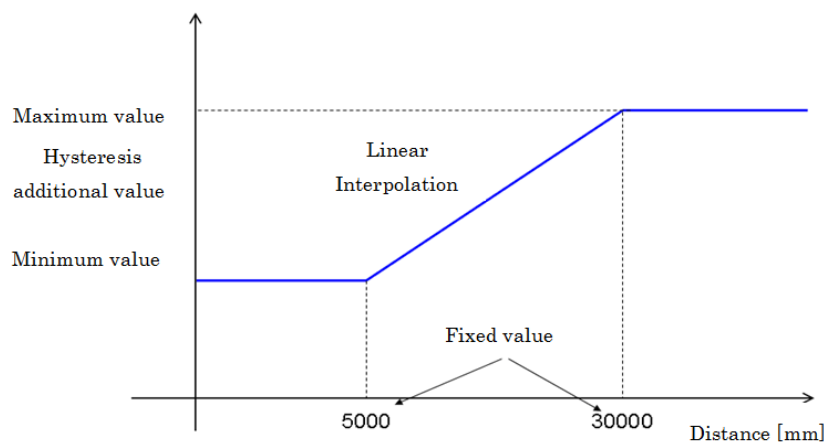
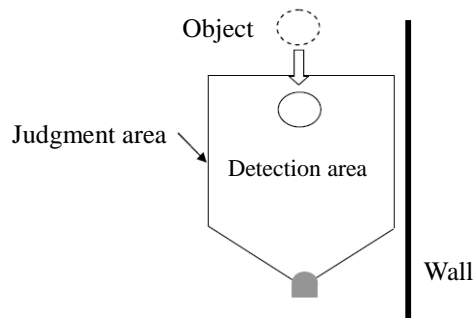

Figure 3-12 Hysteresis additional value

## Note

- When you set the detection area close to a wall, set the hysteresis to the minimum value. If the surface of the wall is within the hysteresis detecting area range, the output will not return to its original state.

- Judgment Area : From object absent to object present



- Judgment Area : From object present to object absent

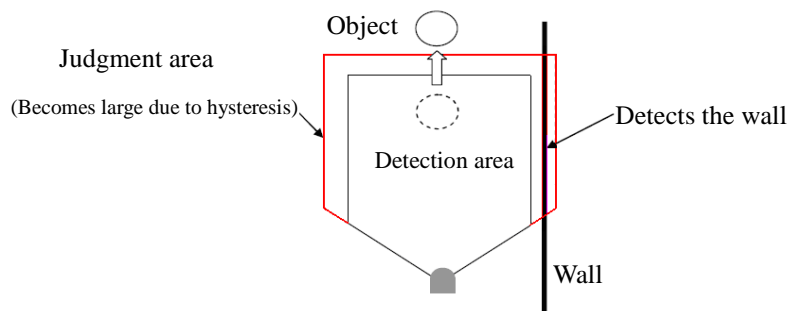

### 3.9 Optical window contamination detection function

When this function is enabled using the configuration application and the optical window is contaminated above certain level, contamination output will switch to ON (High)  $\Delta$ . Even the sensor continue to operate, there will be no malfunction stop. Contamination detection can be set in the following two modes.

#### 3.9.1 Contamination detection (Partial)

Angle specific contamination detection is performed. The angle is configurable using the detection start and end angle setting. The internal contamination sensor values are checked for dirt presence. And then, the dirt effect on distance measurement performance is checked using the detection range threshold.

#### 3.9.2 Contamination detection (All)

The contamination detection is performed for the entire optical window using the internal contamination sensor.

### 3.10 Setting of UGM

Setting of operating parameter of UGM by Area Designer.

Table 3-2 describes UGM's parameters and settings.

Table 3-2 Parameter settings

Parameter	Description								
Motor sync angle	<p>To prevent mutual interference between the sensors, motor synchronous angle can be set by delaying the motor rotation.</p> <table border="1"> <thead> <tr> <th colspan="4">Setting</th> </tr> </thead> <tbody> <tr> <td>0° (Default)</td> <td>90°</td> <td>180°</td> <td>270°</td> </tr> </tbody> </table>	Setting				0° (Default)	90°	180°	270°
Setting									
0° (Default)	90°	180°	270°						
Motor Speed / Angular Resolution	<p>Set the motor speed (scanning cycle) and angular resolution. *After changing the motor speed, switch off and switch on the power supply.</p> <table border="1"> <thead> <tr> <th colspan="3">Setting</th> </tr> </thead> <tbody> <tr> <td>750rpm/ 0.08°</td> <td>1500rpm/ 0.16°</td> <td>3000rpm/ 0.32° (Default)</td> </tr> </tbody> </table>	Setting			750rpm/ 0.08°	1500rpm/ 0.16°	3000rpm/ 0.32° (Default)		
Setting									
750rpm/ 0.08°	1500rpm/ 0.16°	3000rpm/ 0.32° (Default)							
Output logic 	<p>Inverting outputs logic of detection output can be set. (Other outputs are not inverted) Select from below setting.</p> <table border="1"> <thead> <tr> <th>Setting</th> <th>Description</th> </tr> </thead> <tbody> <tr> <td>Active High</td> <td>Invert outputs.</td> </tr> <tr> <td>Active Low (Default)</td> <td>Refer to section 3.11.</td> </tr> </tbody> </table>	Setting	Description	Active High	Invert outputs.	Active Low (Default)	Refer to section 3.11.		
Setting	Description								
Active High	Invert outputs.								
Active Low (Default)	Refer to section 3.11.								

Table 3-2 Parameter settings

Parameter	Description							
Filters	<p>This filter is used to remove the object if the object is not detected stably at the same place. This filter is effective to remove rain and snow detections. Select from below setting.</p> <table border="1" data-bbox="576 371 1358 618"> <thead> <tr> <th>Setting</th> <th>Reference value while using rain filter</th> </tr> </thead> <tbody> <tr> <td>OFF (Default)</td> <td>Filter is not active.</td> </tr> <tr> <td>Low</td> <td rowspan="2">Used to remove the effect of rain with maximum speed up to approx.100mm/h. However, the effect depends upon the installation environment.</td> </tr> <tr> <td>High</td> </tr> </tbody> </table> <p>Caution: When the rain filter is active, The device becomes less sensitive to detect moving object.</p>	Setting	Reference value while using rain filter	OFF (Default)	Filter is not active.	Low	Used to remove the effect of rain with maximum speed up to approx.100mm/h. However, the effect depends upon the installation environment.	High
	Setting	Reference value while using rain filter						
	OFF (Default)	Filter is not active.						
Low	Used to remove the effect of rain with maximum speed up to approx.100mm/h. However, the effect depends upon the installation environment.							
High								
<p>This filter is used to remove reflected light (echoes) from the fog.</p> <p>Select from below setting.</p> <table border="1" data-bbox="564 763 1369 1010"> <thead> <tr> <th>Setting</th> <th>Reference value while using fog filter</th> </tr> </thead> <tbody> <tr> <td>OFF (Default)</td> <td>Filter is not active.</td> </tr> <tr> <td>Low</td> <td rowspan="3">Used in fog when the visibility is approx.100m. However, the effect depends upon the installation environment.</td> </tr> <tr> <td>Medium</td> </tr> <tr> <td>High</td> </tr> </tbody> </table> <p>Caution: When filter is enabled, the device may not detect thin or low reflectance objects. Also, if this filter is set to high, short distance error will occur when fog or objects are detected at 1.5 m or below.</p>	Setting	Reference value while using fog filter	OFF (Default)	Filter is not active.	Low	Used in fog when the visibility is approx.100m. However, the effect depends upon the installation environment.	Medium	High
Setting	Reference value while using fog filter							
OFF (Default)	Filter is not active.							
Low	Used in fog when the visibility is approx.100m. However, the effect depends upon the installation environment.							
Medium								
High								
<p>Sensitivity filter is used to remove the objects with low reflectivity. This filter is effective to remove light interference and rain detections. Select from below setting.</p> <table border="1" data-bbox="576 1267 1358 1525"> <thead> <tr> <th>Setting</th> <th>Reference value while using sensitivity filter</th> </tr> </thead> <tbody> <tr> <td>OFF (Default)</td> <td>Filter is not active.</td> </tr> <tr> <td>Low</td> <td rowspan="3">Difficult to detect object with low reflectivity.</td> </tr> <tr> <td>Medium</td> </tr> <tr> <td>High</td> </tr> </tbody> </table> <p>Caution: Sensitivity filters reduce the capability to detect objects with low reflectivity.</p>	Setting	Reference value while using sensitivity filter	OFF (Default)	Filter is not active.	Low	Difficult to detect object with low reflectivity.	Medium	High
Setting	Reference value while using sensitivity filter							
OFF (Default)	Filter is not active.							
Low	Difficult to detect object with low reflectivity.							
Medium								
High								
Echo* <sup>1</sup>	<p>Echo filter is used in the environment with multiple echoes from the rain, fog, dust, edges of the object or transparent object. Echo filter can be selected first or last.</p> <table border="1" data-bbox="855 1688 1078 1839"> <thead> <tr> <th>Setting</th> </tr> </thead> <tbody> <tr> <td>First (Default)</td> </tr> <tr> <td>Last</td> </tr> </tbody> </table> <p>Filter effect: If there is an obstacles on the front part of the sensor such a cover. Select Last therefore, it is possible to make difficult to detect the obstacles (cover).</p> <p>Caution: When selecting Last, objects smaller than the laser beam size are difficult to be detected.</p>	Setting	First (Default)	Last				
Setting								
First (Default)								
Last								

Table 3-2 Parameter settings

Parameter		Description								
Hysteresis* <sup>1</sup>	Upper limit	Hysteresis upper limit can be set in the range of 0 to 250mm. Hysteresis upper limit cannot be lower the lower limit. Refer to section 3.8 for Hysteresis of detection area. (Default: 0mm)								
	Lower limit	Hysteresis lower limit can be set in the range of 0 to 250mm. Hysteresis lower limit cannot exceed the upper limit. Refer to section 3.8 for Hysteresis of detection area.(Default: 0mm)								
Minimum detectable size* <sup>1</sup>	Width of minimum detectable size can be set in the range of 10 to 1000mm. It is effective for removing light interference, rain or snow etc. related detections. (Default: 10mm)									
Limited detection capacity zone for short distance* <sup>1</sup>	Limited detection capacity zone can be set in the range of 60 to 3000mm. The sensor cannot detect the object which enters at a limited detection capacity zone. This limited detection capacity is used when using a cover on the front part of the sensor. (Default: 100mm)									
Contamination Warning (Partial) * <sup>2,3,4</sup>	Sensitivity	To detect contamination near optical window. In partial setting, judgment is performed within the specified step angle range.								
		<table border="1"> <thead> <tr> <th>Setting</th> <th>Description</th> </tr> </thead> <tbody> <tr> <td>OFF(Default)</td> <td>Function is not active.</td> </tr> <tr> <td>Low</td> <td rowspan="3">When contamination near optical window is detected, the contamination signal is switched ON.<sup>2</sup></td> </tr> <tr> <td>Medium</td> </tr> <tr> <td>High</td> </tr> </tbody> </table>	Setting	Description	OFF(Default)	Function is not active.	Low	When contamination near optical window is detected, the contamination signal is switched ON. <sup>2</sup>	Medium	High
		Setting	Description							
		OFF(Default)	Function is not active.							
		Low	When contamination near optical window is detected, the contamination signal is switched ON. <sup>2</sup>							
Medium										
High										
Detection delay	It is possible to set the time from contamination detection to detection state in the range of 1 to 60s. (Default: 5sec)									
Detection range	Set the contamination detection distance in the range of 35 to 100mm. (Default: 60mm)									
Detection start angle	Set detection start angle during contamination detection in the range of -5 to 185 °.*Cannot input greater value than detection end angle. (Default: -5 °)									
Detection end angle	Set detection end angle during contamination detection in the range of -5 to 185 °.*Cannot input a smaller value than detection start angle. (Default: 185 °)									
Contamination Warning (Whole)* <sup>3,4</sup>	Sensitivity	It is possible to set contamination detection near optical window. In contamination warning (whole) setting, judgment is performed from the dirt on the entire optical window.								
		<table border="1"> <thead> <tr> <th>Setting</th> <th>Description</th> </tr> </thead> <tbody> <tr> <td>OFF(Default)</td> <td>Function is not used.</td> </tr> <tr> <td>Low</td> <td rowspan="3">When contamination near optical window is detected, the contamination signal is switched ON.<sup>2</sup></td> </tr> <tr> <td>Medium</td> </tr> <tr> <td>High</td> </tr> </tbody> </table>	Setting	Description	OFF(Default)	Function is not used.	Low	When contamination near optical window is detected, the contamination signal is switched ON. <sup>2</sup>	Medium	High
		Setting	Description							
OFF(Default)	Function is not used.									
Low	When contamination near optical window is detected, the contamination signal is switched ON. <sup>2</sup>									
Medium										
High										
Detection delay	It is possible to set the time from contamination detection to detection state in the range of 1 to 60s.(Default: 5 sec)									



## Note

- \*<sup>1</sup> In LX type, setting cannot be done.
- \*<sup>2</sup> The device may not operate properly when both fog or sensitivity filter are used.
- \*<sup>3</sup> If direct light (such as sunlight) enters the device, it may not operate properly.
- \*<sup>4</sup> In high or low temperatures, the device may not operate properly.

### 3.11 Output

The UGM has 5 types of outputs as below.

#### 3.11.1 Detection Output 1 to Output 3

Detection Output 1: When an object is detected in the output region 1, ON (High level) state will switch to OFF (Low level) state.

Detection Output 2: When an object is detected in the output region 2, ON (High level) state will switch to OFF (Low level) state.

Detection Output 3: When an object is detected in the output region 3, ON (High level) state will switch to OFF (Low level) state.

#### 3.11.2 Malfunction output

Sensor has self-diagnosis function. This output is switched from ON state (High level) to OFF state (Low level) when internal errors related to active components are detected (laser emission, motor rotation, etc.).

#### 3.11.3 Contamination output

Sensor has self-diagnosis function. This output is switched from OFF (Low level) to ON (High level) when contamination is detected (contamination detection function is enabled).

#### 3.11.4 Synchronous output

Sensor outputs a 1ms pulse in every scan which is synchronized with the scanning starting phase. The timing of the synchronous signal is shown in the figure 3-13. Synchronous output signal is shown in figure 3-14.

\*During Normal mode Scan time : 1scan / 20msec



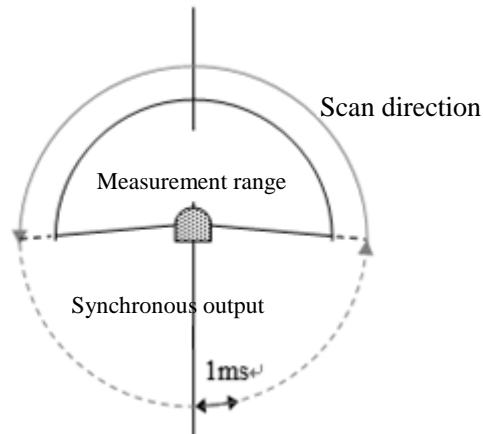

Figure 3-13 The timing of synchronous signal

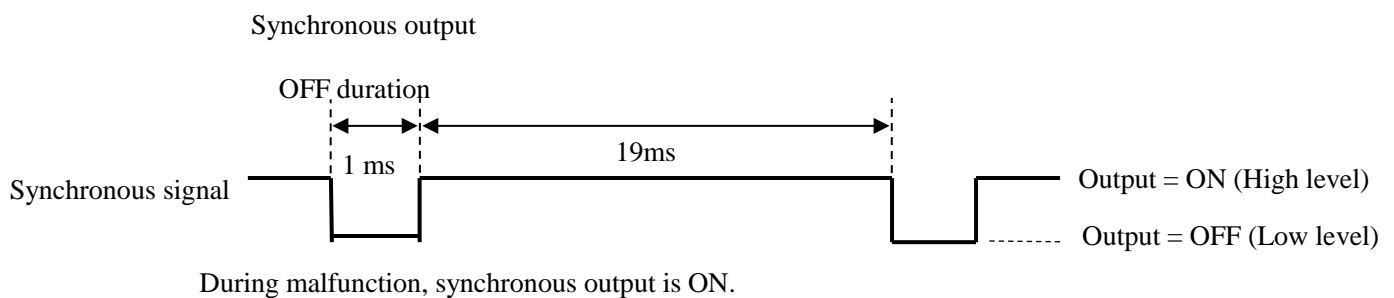

Figure 3-14 Synchronous output signal

### 3.11.5 Synchronous master output

This is a reference clock signal for synchronizing motor rotation of each sensor. The output is continued even in the malfunction state.

For synchronous operation, synchronous master output of master unit is connected to synchronous input of all slave units including master unit. For details on the wiring of synchronous operation, refer to chapter 4.6 (Synchronous operation)

## 3.12 Input

The UGM has four types of inputs as below.

### 3.12.1 Area Input 1 to Input 4

These inputs are used in order to choose detection area. table 3-1 shows the relation between input states and corresponding area number.

### 3.12.2 Synchronous input

For synchronous operation, synchronous master output of master unit is connected to synchronous input of all slave units including master unit. For details on the wiring of synchronous operation, refer to chapter 4.6 (Synchronous operation)



### 3.12.3 Reboot input

When switch ON (High level) for 2 seconds or more, restarts the sensor operation.

### 3.12.4 IP reset input

Return the IP address to the initial value (192.168.0.10).

For IP address initialization, switch ON (High level) for 2 seconds or more, then switch OFF (Low level).

Caution: Make sure that the IP reset input is Low level before switch OFF the sensor power supply.

If the power supply of the sensor is switched OFF while the IP reset input is high level, the sensor may not start normally.

## 3.13 Indicator lamp

4 LED display indicates the UGM status. This LED display is located on the top of the UGM as shown in figure 3-15. Table 3-3 shows the description of the LEDs.

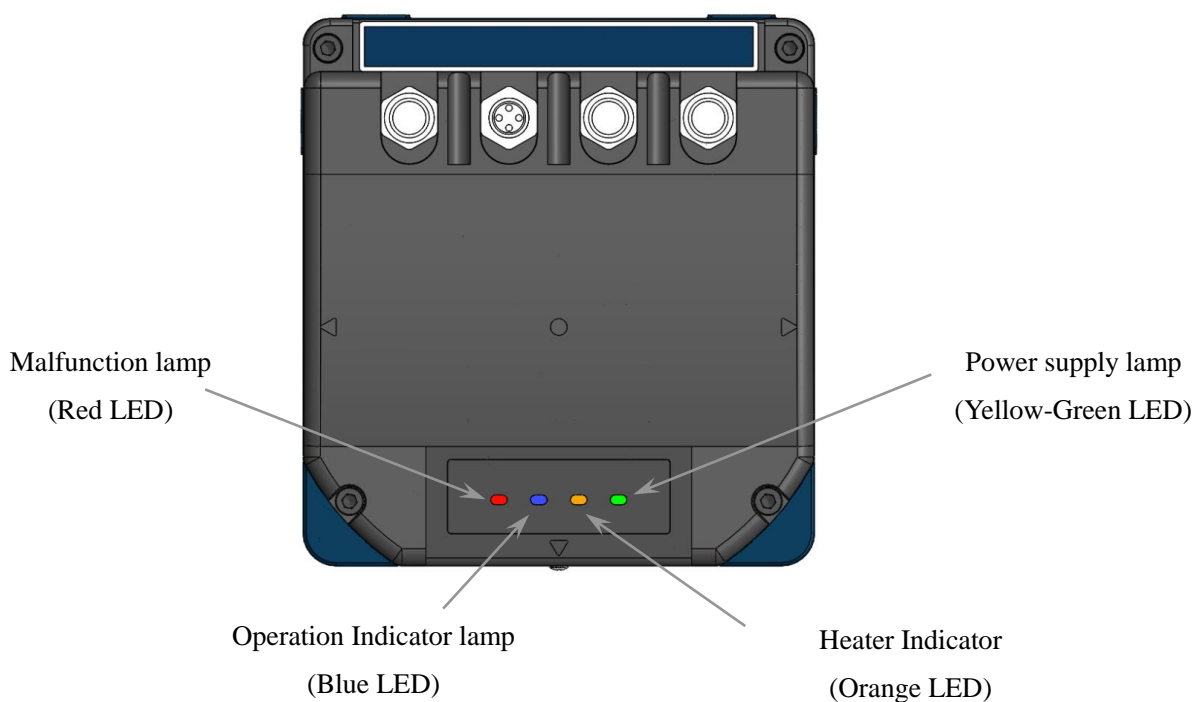

Figure 3-15 Indicator lamp (For explanation, all the indicator lamps are ON)

Table 3-3 Relation table between Indicator lamp (LED) and output signals

Sensor state	LED				Synchronous master output	Synchronous output	Contamination output	Malfunction output
	Yellow -Green	Orange*1	Blue	Red				
During start up	ON	OFF	Blink	OFF	After power supply always output ON	Tr=ON(High)	Tr=ON(High)	Tr=ON(High)
During operation	ON	OFF	OFF*2	OFF		1ms per cycle Tr=OFF(Low)	Tr=OFF(Low)	Tr=ON(High) ⚠
			ON*2			Tr=ON(High)	Tr=OFF(Low)	Tr=OFF(Low) ⚠
Malfunction	ON	OFF	OFF	ON		Tr=ON(High)	Tr=OFF(Low)	Tr=OFF(Low) ⚠
Sleep	ON	OFF	Blink	OFF		Tr=ON(High)	Tr=OFF(Low)	Tr=ON(High) ⚠
During contamination	Same as operation					Same as Operation	Tr=ON(High)	Tr=ON(High) ⚠
Initialization of IP	ON	OFF	Blink	Blink		Tr=ON(High)	Tr=OFF(Low)	Tr=OFF(Low)

\*1. The orange LED is ON when you use heater.

\*2. The behavior of blue LED during operation differs between LXP type and LAP type.

LXP type: OFF / LAP type: ON when detecting within the area

\*Immediately after power supply ON, output will be in unstable state.

The unstable period depends on the motor speed.

\*It is only possible to inverse detection output with application software.

(Default: During detection Tr = OFF (Low)) ⚠

### 3.14 Heater function

In this sensor heater is internally mounted to prevent condensation in the optical window. The application allows the Heater Function ON (use) or OFF (not use). The initial operation mode of heater function is OFF. When the heater function is ON (use), the heater will operate if the temperature inside the sensor decreases below 0°C. When the temperature inside the sensor increases more than 10°C, the heater stops its operation automatically.



## 4. Installation

This chapter describes precautions during sensor installation.

### 4.1 Caution of Installation

The UGM can be fixed with four M8 screws using mounting holes (eight places) at the back or side of the case. Mount the sensor at a height of 500mm or more above the floor. As shown in the figure 4-1, the spread of the laser beam differs on the front and the side.

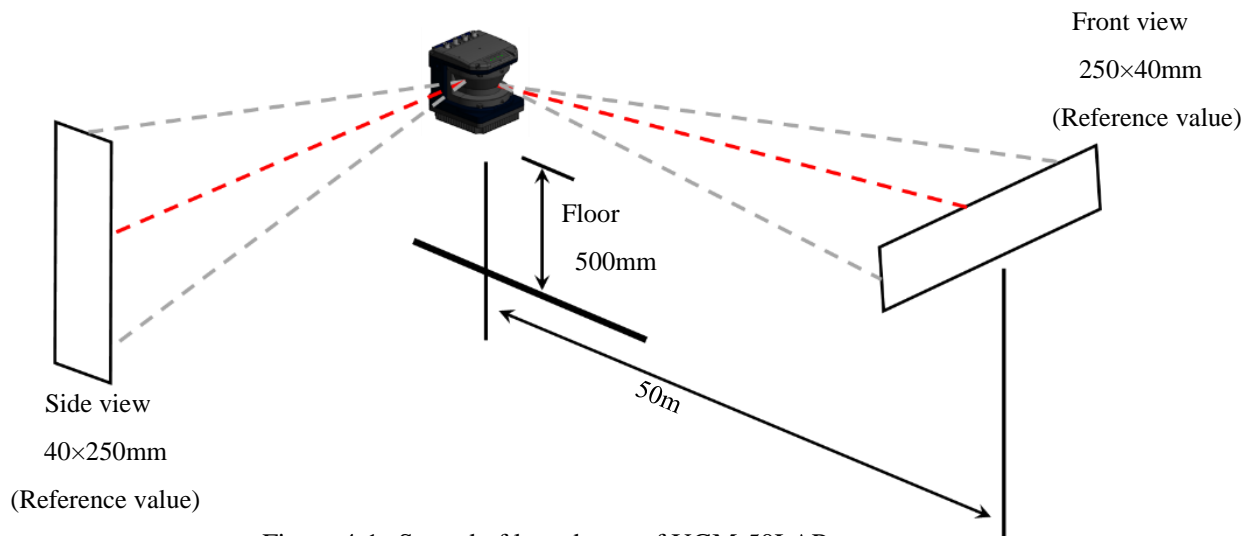

Figure 4-1 Spread of laser beam of UGM-50LAP



#### Caution

- Fix the sensor firmly so that the optical axis is not displaced by vibration or shock.
- Make adjustment of the angle, if mounting height cannot be ensured.
- Mounting plate is used as a frame ground (FG). Mount the sensor on a stable structure.



**Caution**

- When attaching a cover, etc. to the UGM, you must not cover the red frame as shown in figure 4-2. False detection may occur.

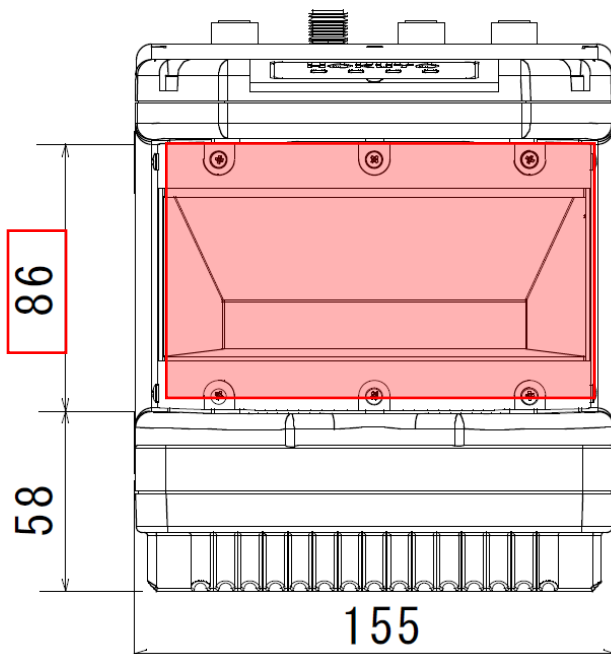

Figure 4-2 Cautions during installation

**4.2 Optical axis adjustment**

Angular tolerance with respect to structure axis is  $\pm 0.3^\circ$  in the horizontal plane and  $\pm 1^\circ$  in the vertical plane as shown in figure 4-3. Use an adjustment mechanism to precisely adjust the detection plane. Detection plane can be checked by Optical-Axis Checker (Model: UES-930, Sold separately)

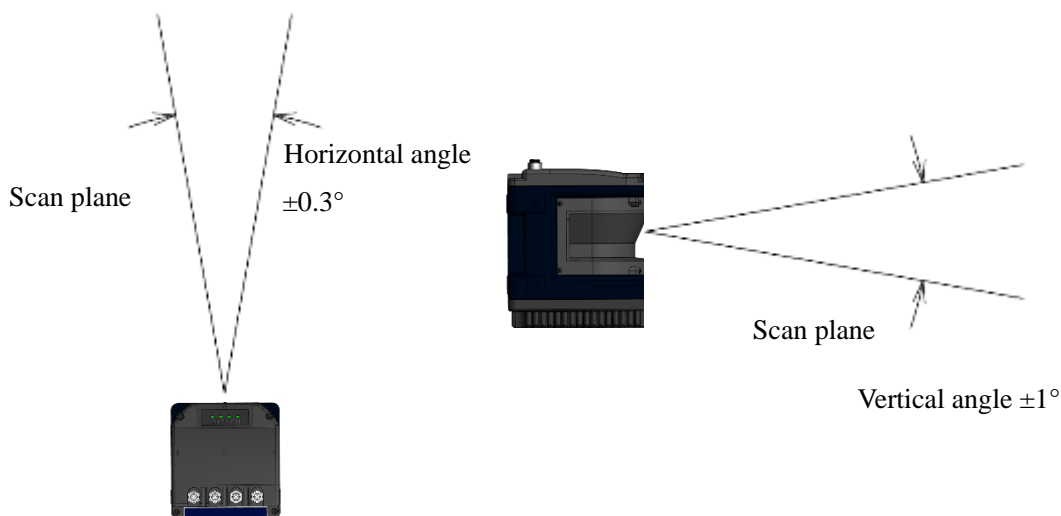

Figure 4-3 Angular Tolerance with Respect to Structure Axis



### 4.3 Light interference

The UGM uses a pulsed laser for object detection. Light interference sources could lead to false detection. User should examine the surrounding environments before installation the UGM. If the light source cannot be avoided during the operation, then UGM should be installed with the light source located at  $\pm 5^\circ$  or more from the detection plane in order to prevent interference. When sensitivity filter is selected, it might be effective to avoid light interference.

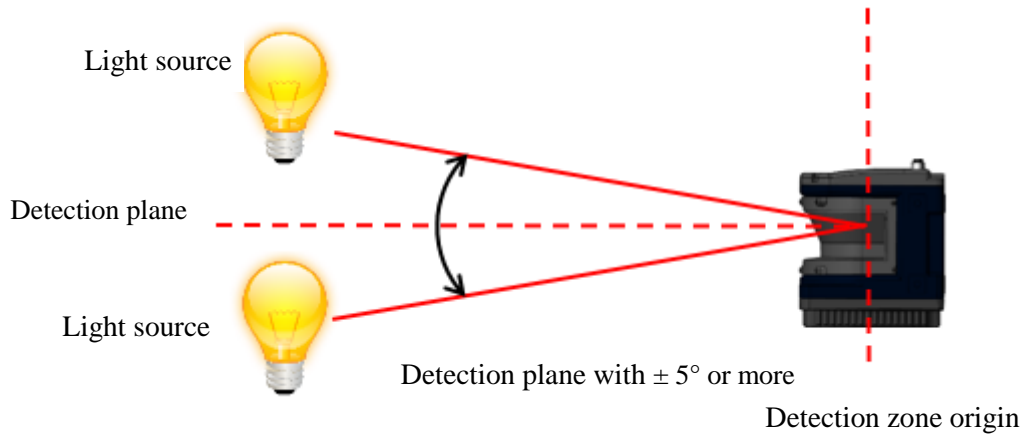

Figure 4-4 Installation under light interference

### 4.4 Contamination on the optical window

The detection capability of UGM could affect if water drops or contamination on the optical. The object within the distance of approx.700mm will be as shown in figure 4-5. If water drops or contamination on the optical window, clean the optical window. (Refer to section 8.5)

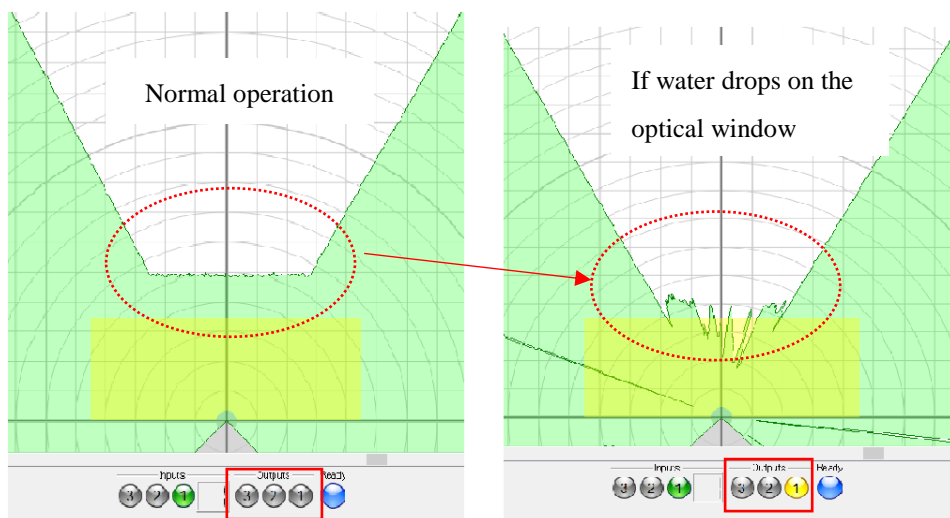

Figure 4-5 Effect due to water drops

## 4.5 Mutual interference

Extra precautions are required while using two or more identical UGM sensors because pulsed laser signals from identical UGM units could lead to false detection. Figures below show the installation method for avoiding mutual interference.

### a) Changing the height of installation

Displace the installation position up and down; mutual detection original point of the UGM should be separated 5 ° or more from detection plane.

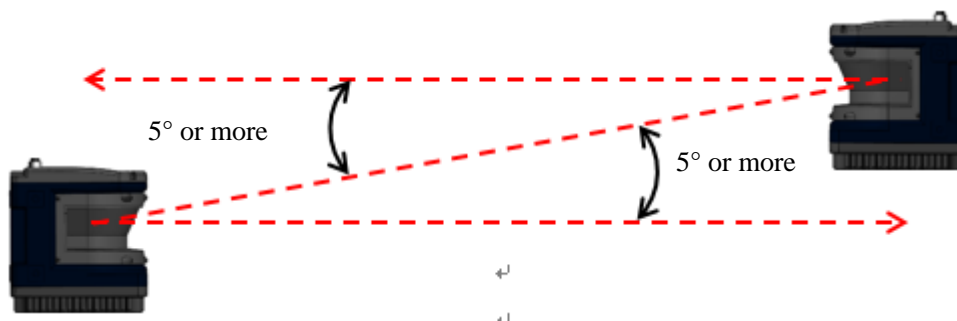

Figure 4-6 Opposite facing installation

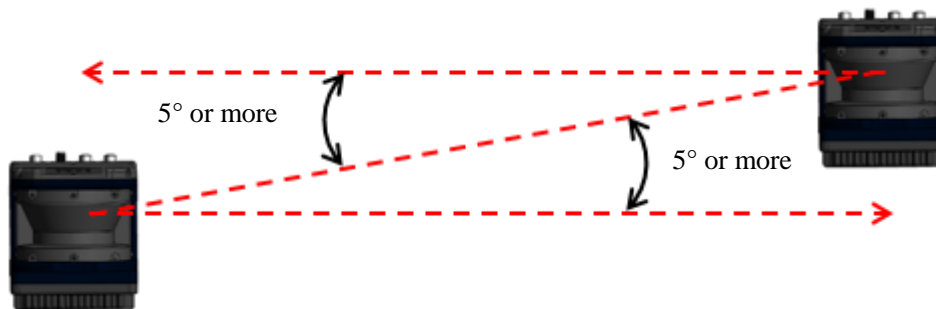

Figure 4-7 Parallel installation

### b) Changing the angle of installation

The installation angle of the UGM is changed; mutual detection original point of the UGM should be separated 5 ° or more from detection plane.

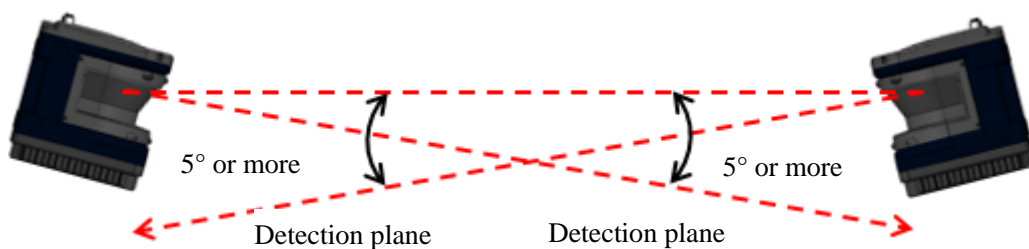

Figure 4-8 Opposite facing installation

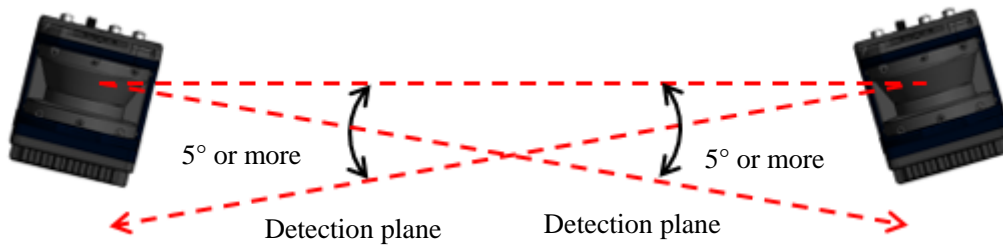

Figure 4-9 Parallel installation

## c) Adding shield in between UGM

By adding a shield in between the UGM units, laser beam cannot reach the opposite sensor so this will avoid possible mutual interference.

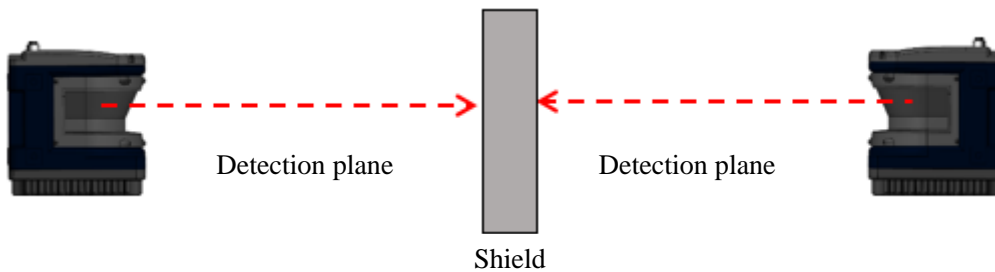

Figure 4-10 Opposite facing installation

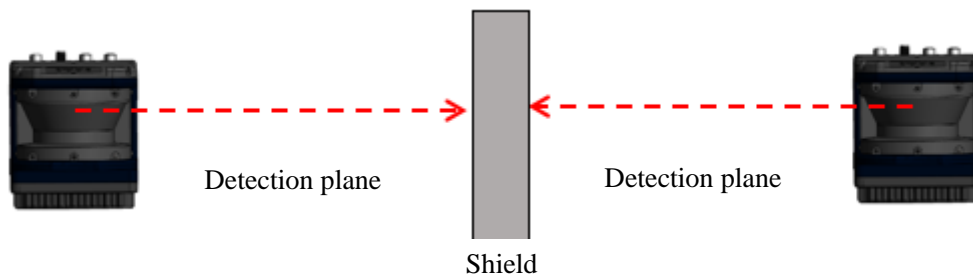

Figure 4-11 Parallel installation

**Note**

- Use solid or non-transparent material for shield.



### 4.6 Synchronous operation

When operating two or more UGM units within short distance, mutual interference may occur. To prevent mutual interference between them, the rotation of UGM units can be synchronized (However, this cannot guarantee 100% prevention of mutual interference, depending upon the installation condition, background condition, etc., of each UGM. If interference cannot be avoided, then verify the installation condition before the operation).

It is possible to synchronize four UGM: one master and other three slaves. For synchronous operation, synchronous master output of master unit is connected to synchronous input of all slave units including master unit.

Connection example is shown in figure 4-12. Configure the master and all slaves to the same rotation speed (750rpm / 1500rpm / 3000rpm). If master and slave are configured with different rotation speeds, they may not synchronize properly.

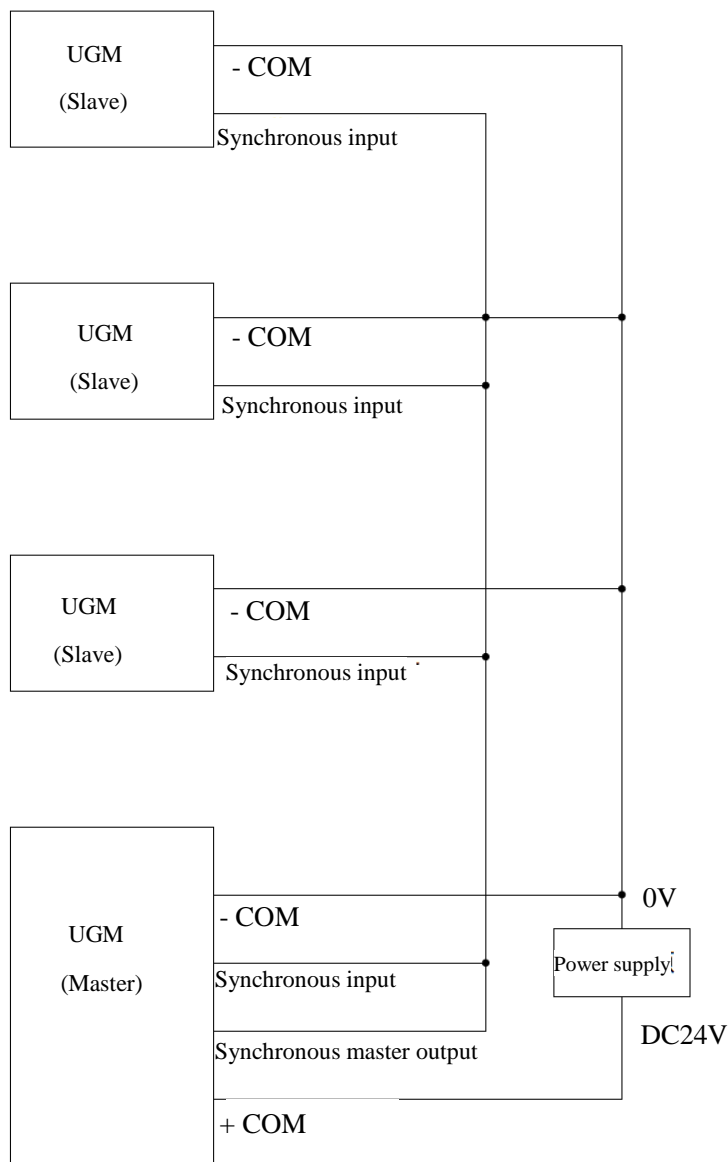
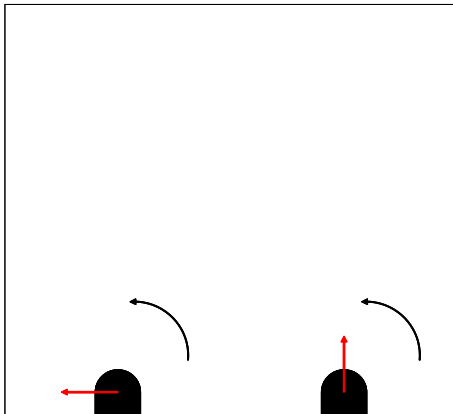

Figure 4-12 Example of synchronous wiring (when wiring four UGM)

Phase settings are shown in figure 4-13 to figure 4-15 when installing multiple units of UGM.

a) Parallel installation



Master Phase:  $0^\circ$       Slave Phase:  $90^\circ$

To prevent mutual interference between  
2 units of UGM in a parallel installation.  
Set Master unit phase:  $0^\circ$   
Slave unit phase:  $90^\circ$

Figure 4-13 Example of parallel installation

b) Opposite facing installation

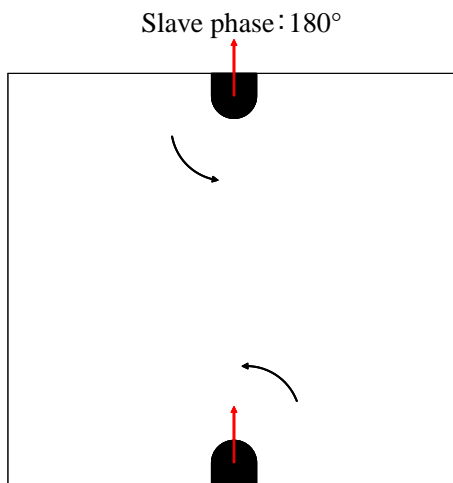

Master phase:  $0^\circ$

Slave phase:  $180^\circ$

To prevent mutual interference between  
2 units of UGM opposite facing installation.  
Set Master unit phase:  $0^\circ$   
Slave unit phase:  $180^\circ$

Figure 4-14 Example of opposite facing installation

## c) Installing 4 units of UGM

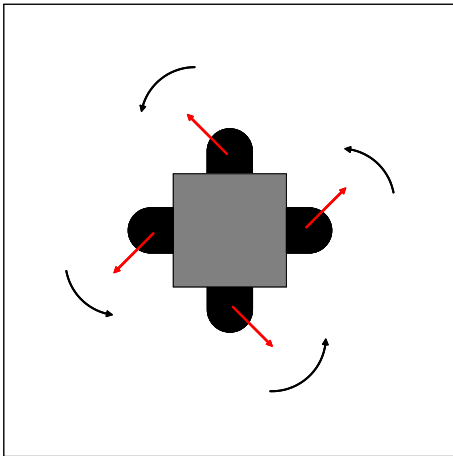
Master/ Slave phase:  $0^{\circ}$ 

To prevent mutual interference between 4 units of UGM installed facing 4 different directions.

Set Master unit phase:  $0^{\circ}$ Slave unit phase:  $0^{\circ}$ 

Figure 4-15 Example of installing 4 units

Mutual interference could occur when multiple identical sensors are mounted on the same detection plane. The sensor cannot differentiate the self emitted laser pulse and the identical pulse from the other device causing the measurement error. Use ON delay setting to prevent such mutual interference.

## 5. Wiring

This chapter describes precaution when wiring the UGM.

### 5.1 Precautions

During electric wiring, make sure that all devices are disconnected from power supply. Switch OFF all the power supply during wiring.

### 5.2 Power supply

Make sure that power supply within the operation voltage range of  $24V \pm 10\%$ . If the rated output voltage exceeds this range, UGM could be damaged.

When a converter is used as power supply, make sure that it fulfills the following requirements.

- A rated output voltage within range of DC  $24V \pm 10\%$ .
- Use power source with 3.5A or more (During DC24V) current capacity. 
- The power supply must comply with the requirements of electromagnetic compatibility (EMC) regulations of the respective country, states and district.



**Danger** ● For safety, switch off all the power supply during wiring.



**Caution**

- If there is an electric potential difference between the UGM and ground of other connected devices, then there is a possibility of malfunction due to noise or of damage. Prevent this by using potential equalization, isolation, etc.

### 5.3 Pin assignments and function

Table 5-1 shows the pin assignments of each connector, signal name, function, etc.

The function differs in each mode.

Table 5-1 Pin assignments and function

Power supply connector

M12 4 core A code socket (Female)

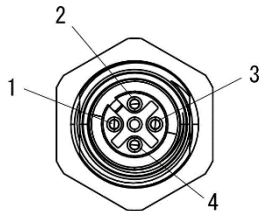

PIN No.	Function
1	Sensor power supply + V (24V ±10%)
2	Sensor power supply GND - VIN (0V)
3	Heater power supply (24V ±10%)
4	Heater power supply GND (0V)

Ethernet Connector

M12 4 core D code plug (Male)

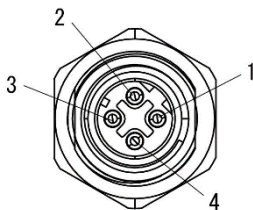

PIN No.	Function
1	TX+
2	RX+
3	TX-
4	RX-

\*Input/output direction is defined from the sensor point of view (sensor as reference).



## 5.4 Input/ Output circuit

### 5.4.1 Input circuit

Photo coupler input circuit (cathode COM, each Input ON current 5mA, OFF current 0.5mA or less)

### 5.4.2 Output circuit

PNP Open-collector output circuit

Table 5-2 Output circuit specification

Item	Specification
Maximum output current	50mA
Maximum voltage	30V
Output residual voltage	1V or less
Power supply range at +COM	24V±10%

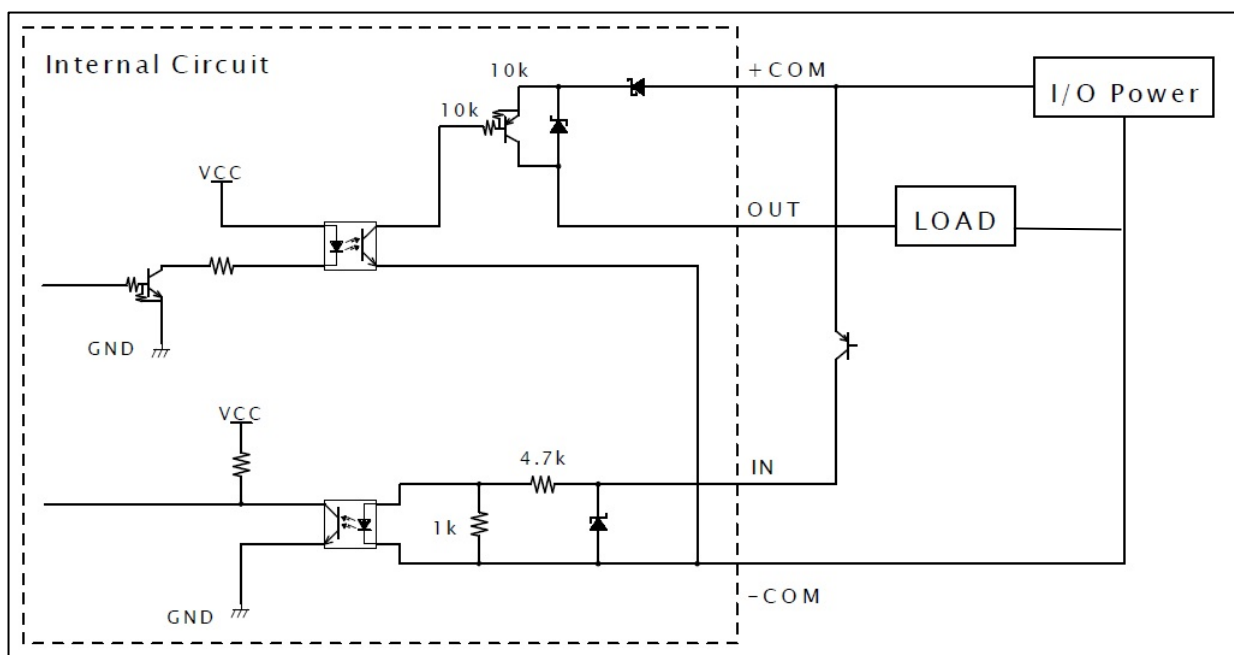

Figure 5-1 Example of connecting input / output circuit



#### Caution

- Input cable should be connected to - COM when not in use.
- Output cable should be open when not in use.
- Output connection requires limit resistors.

## 5.5 Interface connector

### 5.5.1 Power supply connector

Power supply connector is used for sensor power supply.

Use power supply and I/O cable (sold separately as option) to connect power supply and sensor.

Pin assignments for each plug are shown in figure 5-2 and table 5-3.

#### Connector (Sensor side)

M12 4 core A code socket (Female)

Maker: GT CONTACT

Type: GT234103-02040

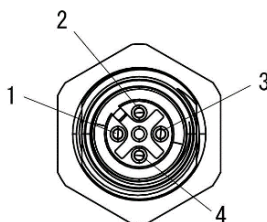

Figure 5-2 Power supply connector

Table 5-3 Power supply Input / Output Connector pin assignment

PIN No.	Function
1	Sensor power supply + V (24V $\pm$ 10%)
2	Sensor power supply GND - VIN (0V)
3	Heater power supply (24V $\pm$ 10%)
4	Heater power supply GND (0V)

- Power supply cable as optional item.

Table 5-4 shows optional item types and table 5-5 shows pin assignment.

Table 5-4 Power supply Input/output Connector cable

Code No.	Name	Type
UZ00121	UGM-4PC005 UGM Power supply cable (5m)	UGM-4PC005

Table 5-5 Power supply Input/output Connector pin assignment

PIN No.	Function	Wiring color
1	Sensor + VIN (24V $\pm$ 10%)	Brown
2	Sensor - VIN (0V)	Blue
3	Heater 24V $\pm$ 10%	White
4	Heater 0V	Black



### 5.5.2 Ethernet connector

Ethernet connection is used for sensor settings, distance data output etc. Use Ethernet connection cable (sold separately as option) to connect PC and sensor.

Pin assignments for each plug are shown in figure 5-3 and table 5-6.

#### Connector (Sensor side)

M12 4 core D code plug (Male)

Maker: GT CONTACT

Type: GT234413-02040

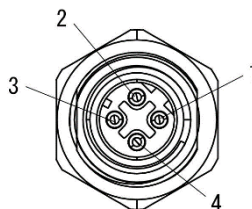

Figure 5-3 Ethernet Connector (Sensor side)

Table 5-6 Ethernet Connector pin assignment

PIN No.	Function
1	TX+
2	RX+
3	TX-
4	RX-

- Ethernet connection cable is an optional item

Table 5-7 shows option item types and table 5-8 shows pin assignment.

Table 5-7 Ethernet Connector cable

Code No.	Name	Type
UZ00122	UGM-ENET005 UGM Ethernet cable (5m)	UGM-ENET005

Table 5-8 Ethernet Connector cable pin assignment

M8 Connector		
PIN No.	Function	Color
1	TX+	Orange
2	RX+	Green
3	TX-	Orange/White
4	RX-	Green /White

RJ45		
PIN No.	Function	Color
1	TX+	Orange
2	TX-	Orange/White
3	RX+	Green
6	RX-	Green /White



### 5.5.3 I/O1 Connector (8pin)

I/O 1(8pin) connector is used for sensor power supply, I/O input and output.

Use I/O (8pin) cable (sold separately as option).

Pin assignments for each plug are shown in figure 5-4 and table 5-9.

#### Connector (Sensor side)

M12 8 core A code socket (Female)

Maker: :GT CONTACT

Type: GT234103-01080

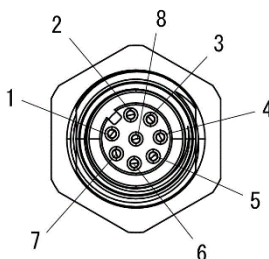

Figure 5-4 I/O1 Connector (Sensor side)

Table 5-9 I/O1 Connector pin assignment

PIN No.	Function
1	Reboot
2	IP Reset
3	Synchronous input
4	Synchronous output
5	Synchronous master output
6	NC
7	+COM
8	-COM

- I/O1 connection cable is an optional item.

Table 5-10 shows option item types and table 5-11 shows pin assignment.

Table 5-10 I/O1 Connector cable

Code No.	Name	Type
UZ00123	UGM-8PC005 UGM 8pin I/O cable (5m)	UGM-8PCC005

Table 5-11 I/O1 Connector cable pin assignment

PIN No.	Function	Color
1	Reboot	Brown
2	IP Reset	White
3	Synchronous input	Orange
4	Synchronous output	Yellow
5	Synchronous master output	Green
6	NC	Blue
7	+COM	Purple
8	-COM	Black

### 5.5.4 I/O2 Connector (12pin)

I/O2 (12pin) connector is used for sensor power supply, I/O input and output.

Use I/O2 (12pin) cable (sold separately as option)

Pin assignments for each plug are shown in figure 5-5 and table 5-12.

#### Connector (Sensor side)

M12 12 core A code socket (Female)

Maker: : GT CONTACT

Type: GT234103-04120

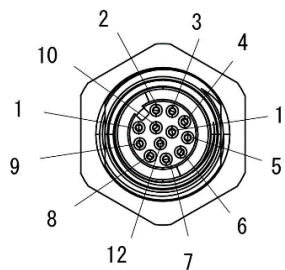

Figure 5-5 I/O2 Connector (Sensor side)

Table 5-12 I/O2 Connector pin assignment

PIN No.	Function
1	Contamination output
2	NC
3	Malfunction output
4	Area output 1
5	Area output 2
6	Area output 3
7	Area input 1
8	Area input 2
9	Area input 3
10	Area input 4
11	+COM
12	-COM

- I/O2 connection cable is an optional item.

Table 5-13 shows option item types and table 5-14 shows pin assignment.

Table 5-13 I/O2 Connector cable

Code No.	Name	Type
UZ00124	UGM-12PC005 UGM 12pin I/O cable (5m)	UGM-12PC005

Table 5-14 I/O2 Connector cable pin assignment

PIN No.	Function	Color
1	Contamination output	Black
2	NC	Brown
3	Malfunction output	Red
4	Area output 1	Orange
5	Area output 2	Yellow
6	Area output 3	Green
7	Area input 1	Blue
8	Area input 2	Purple
9	Area input 3	Gray
10	Area input 4	White
11	+COM	Pink
12	-COM	Yellow-Green



## 6. Setting of Area Designer

Install the application software (Area Designer) in a supported operating system and connect UGM using an Ethernet cable. (For details refer to chapter 13).

Area Designer has the following functions:

- Configuration of detection area
- Configuration of various UGM functions
- Display of measurement data
- Record and playback of measurement data
- Project data management (Save and open of project data).

### 6.1 Area Designer

Application software (Area Designer) can be downloaded from our homepage.

For details of installation and operation please refer to Area Designer sensor configuration tool Instruction manual. (C-41-02621)

### 6.2 System requirements

Table 6 -1 Minimum system required for Area Designer

PC	CPU	Pentium®IV processor of 800MHz or above
	RAM	512MB or more
	Hard disk	150MB minimum free space
Compatible OS	Microsoft® Windows 7 Professional	
	Microsoft® Windows 10	
Display	High color (16 bit color) or above , 800×600 dot or above	

Microsoft®, Windows® are the registered trademarks of Microsoft Corporation USA.

The operation in the below system environment cannot be guaranteed.

- Other OS that is not mentioned above
- NEC PC98 series and its compatible device
- Self-assembled PC
- Multi boot environment
- Multi monitor environment

#### Note

- Operation is not guarantee even if the system requirements are fulfilled.
- Read thoroughly the Instruction manual of Area Designer for configuring UGM. Instruction manual can be loaded from the help menu of Area Designer.

## 7. Communication

### 7.1 Ethernet setting

#### 7.1.1 Initial value

Initial value of IP: 192.168.0.10

Port No.: 10940

#### 7.1.2 Changing IP address

It is possible to change and reset the IP address using a specialized application (IP Discovery). For details on installation and operation of IP Discovery, please refer to IP discovery manual. (C-41-02603)



## 7.2 Communication protocol

For details on the communication protocol, refer to Communication specification (C-42-04403).

## 7.3 Error code table

The cause of an error can be obtained from STAT line of the “IP” Command response, in the SCIP communication protocol. The error codes and solutions from the STAT line are shown in table 7-1.

If the same error occurs even after restarting the sensor, it is necessary to repair the sensor.

Please contact our nearest distributor or sales representative.

Table7-1 Error code

ID	Message	Meaning
000	no error.	Normal operation
051	system setup failed.	Sensor internal processing error
052	internal chip access failed.	
100		
200	encoder error.	Encoder error
201		
250	motor startup failed.	Motor error
251	motor rotation error.	Unstable motor rotation
300	laser too high.	Laser error
301	laser too low.	
302	laser no echo.	

## 7.4 Detail on measurement values

The meaning of the distance value (x) of each step measured in SCIP communication is shown in table 7-2. In the data table of Area Designer, the displayed value will differ if there is an error or no echo. The Area Designer value are shown in Table 7-3.

Table 7-2 Distance value of SCIP communication

Range of the distance value	Meaning	
$35 \leq x \leq 160,000$	Distance	Measured distance (mm)
$x = 262,140$ (3FFFC)	No echo	No object is detected or the level is too low (Level value will be 0)
$x = 262,142$ (3FFFE)	Short distance error	When distance to object is 35 mm or less (LX type) Within the limited detection capacity zone (LA type)
$x = 262,143$ (3FFFF)	Long distance error	When detected object is 160,001 mm or more

Table 7-3 Area Designer value

Meaning	Distance	Level
Short distance error (35mm or less)	196602	Exist
Long distance error (160,001 mm or more)	196605	Exist
No echo	196596	0
No echo (low level)	196596	0



## 8. Inspection and maintenance

Inspection and maintenance are necessary for safe operation. User must ensure that inspection and maintenance are carried out as specified. Before performing inspection and maintenance, confirm the following items.

- The machine monitored by the UGM is switched OFF.
- The surrounding of the working environment is safe.



### **Danger**

- Do not modify or disassemble the UGM during inspection as this will affect the detection capability of the sensor leading to critical injury or death.



### **Caution**

- This manual only suggests the basic steps for inspection and maintenance. User should perform additional inspection and maintenance if needed. User should follow necessary steps in accordance to the working environment.
- Depending upon the operating environment, follow the necessary procedure.
- All inspections should be performed during initial commission of the UGM.



## 8.1 Pre-operation inspection

After configuration is completed, pre-operation inspection test should be performed using a test piece. User should perform this inspection without connecting the sensor to the system. Table 8-1 shows an example of pre-operation inspection items list.

Table 8-1 Pre-operation inspection list

No.	Check item	Condition		Remark
		Yes	No	
1	UGM is correctly mounted at the intended location and screws are firmly fastened			
2	All the wirings are correctly connected			
3	When the test piece is placed in the detection area Output 1 to 3 switch from ON state to OFF state			
4	When the test piece is removed from the detection area Output 1 to 3 switch from OFF state to ON state			
5	Area switching is according to input signal			

\* Must check items 3 and 4 for all the areas.

## 8.2 Operation inspection

This test should be performed when pre-operation inspection is completed. This operation inspection must be performed with sufficient safety measures been taken. If this inspection test is done before pre-operation test, then the system can get damaged. Table 8-2 is an example of operation inspection list.

Table 8-2 Operation inspection list

No.	Check item	Condition		Remark
		Yes	No	
1	When the test piece is placed in the detection area Output 1 to 3 switch from ON state to OFF state			
2	When the test piece is removed from the detection area Output 1 to 3 switch from OFF state to ON state			
3	Area switching is according to input signal			
4	Predetermined system operation is carried out as expected			

\* Must check items 1 and 2 for all the areas.



### 8.3 Daily inspection

Below table 8-3 shows an example of the items that should be checked during daily inspection.

Table 8-3 Daily inspection list

No.	Check item	Condition		Remark
		Yes	No	
1	UGM is correctly mounted at the intended location and screws are firmly fastened			
2	All the wirings are correctly connected			
3	When the test piece is placed in the detection area Output 1 to 3 switch from ON state to OFF state			
4	When the test piece is removed from the detection area Output 1 to 3 switch from OFF state to ON state			
5	Area switching is according to input signal			
6	Predetermined system operation is carried out as expected			

\* Must check items 3 and 4 for all the areas.

## 8.4 Periodical inspection

Periodical inspection should be performed to ensure the detection capability of the UGM. Table 8-4 below shows an example list of periodical inspection items. It is recommended to perform this inspection in six months interval. This inspection should be performed together with daily inspection.

Table 8-4 Periodical inspection list

No.	Check item	Condition		Remark
		Yes	No	
1	Screw are tightly fastened			
2	No displacement from the original mounting position			
3	No scratch or crack on the optical window			
4	Screws of the optical window are tightly fastened			
5	No oil/grease or dirt on the optical window			
6	No visible damage on the UGM			
7	Cable connector is in good condition and tightly fastened			
8	When the test piece is placed in the detection area Output 1 to 3 switch from ON state to OFF state			
9	When the test piece is removed from the detection area Output 1 to 3 switch from OFF state to ON state			
10	Area switching is according to input signal			
11	Pre-determined system operation is carried out as expected			

\* Must check items 8 and 9 for all the areas

### Note

- For the traceability purposes, it is recommended to maintain and store the maintenance and inspection records.



## 8.5 Cleaning the optical window

Dust covering the optical windows affects the detection capability of the UGM. When you install UGM in the dusty environment, regular cleaning of the optical window is needed.

According to the contamination situation follow the below method:

- Blow off the dust on optical window using air-blower.
- Wipe the optical window with a clean soft cloth.
- Clean the optical window with mild detergent if it is contaminated with oil/grease particles.

Next, wipe off the mild detergent with water.

Insufficient wiping may cause cracking of the plastic

Finally, wipe with soft clean cloth

Example of soft cloth ... Bencot M-3 II (Asahi KASEI)



### Caution

- Do not use organic solvents (such as thinner, benzene and acetone) for cleaning. Plastics parts and paint might be affected.



### Danger

- Disconnect the system when cleaning the optical window.
- If above-mentioned contents are not followed it could lead to serious damage on the machine, critical injury and death.

## 9. Troubleshooting

While using this sensor, if problem occurs, then refer to the following table.

Table 9-1 Troubleshooting list

Situation	Possible reason	Solution suggestion
UGM is not operating	Power supply is OFF /Over voltage/ Under voltage	Make sure that power supply is ON. Voltage is within the specification.
	Cable is damaged	Make sure that cable is in good condition.
Yellow-Green LED does not lit	Normal voltage is not supplied.	Make sure that voltage is within the specification.
UGM does not connect with Area Designer	PC trouble	Check the PC's specification. Make sure that the specification is compatible. Close other unrelated applications and reconnect.
	Power supply is OFF	Make sure that the power supply is ON.
		Voltage is within the specification.
		Power supply cable is in good condition.
	Ethernet cable is not connected to LAN port	Make sure that the Ethernet cable is connected to both PC and UGM.
IP address of PC is not set	Set the IP address of the PC (Refer to below URL). <a href="https://www.hokuyo-aut.co.jp/products/data.php?id=4">https://www.hokuyo-aut.co.jp/products/data.php?id=4</a>	
Obstacles are not detected inside the selected detection area	Power supply is OFF	Voltage is within the specification.
	UGM is in malfunction state	Make sure that malfunction lamp (red LED) is in normal state. Restart UGM if it is lit.
Output remains OFF even if no object in the detection area	Light interference	Mount UGM at a location free from light interference. Refer to chapter 4 Light interference for counter measures.
	Mutual interference	Refer to chapter 4 Mutual interference and synchronous operation for counter measures.
	Contaminated optical window	Check for any contamination or damage on the optical window.
	Floor is detected	Make sure that floor is not detected. Reconfigure the detection area.
	Background is detected	Make sure that the background is not within the detection area. Reconfigure the detection area.
	Hysteresis setting	Reconfirm the hysteresis setting.(Refer to section 3.8)
	Area setting	Without an area configured area number is selected.





- For repairing the UGM, please contact our nearest distributor or sales representative. Do not repair or disassemble the UGM. Such modifications will void the warranty.

## 10. Specification

Product name	2D LiDAR
Model	UGM-50LAP, UGM-50LXP
Light source	Laser semiconductor (905nm), FDA Laser class 1 (IEC60825:2014)
Supply voltage of sensor	DC24V $\pm$ 10%
Supply current of sensor	Steady current : 1.5A or less (Without heaters* <sup>1</sup> ) Start up current : 1A or less (Without heaters* <sup>1</sup> )
Power consumption of sensor	24W or less (During steady current, and without heaters)
Supply voltage of heater	DC24V
Supply current of heater	Steady current, Start up current : 2A or less (Only heaters* <sup>2</sup> )
Power consumption of heater	48W or less
Detection range and object	0.1m to 50m* <sup>3</sup> (Black paper Reflectance 10% 500mm $\times$ 500mm ) 0.1m to 120m* <sup>4</sup> (White Kent sheet Reflectance 90% 1400mm $\times$ 1400mm ) Maximum detection distance: 120m (Distance output range 160m) Minimum detectable size Normal mode: 65mm (5m) , 130mm (10m), 260mm (30m) High Resolution mode : 33mm (5m) , 65mm (10m), 130mm (30m)
Average Accuracy by distance	10% Reflectance Black paper 0.1m to 30m : $\pm$ 30mm, 30m to 50m : $\pm$ 40mm Indoor : 1,000lx or less 0.1m to 50m : $\pm$ 50mm* <sup>5</sup> Outdoor: 100,000lx or less 90% Reflectance white Kent paper 0.1m to 50m : $\pm$ 30mm Indoor : 1,000lx or less 0.1m to 50m : $\pm$ 50mm* <sup>5</sup> Outdoor: 100,000lx or less
Measurement resolution	1mm
Repeat accuracy	10% Reflectance Black paper 0.1m to 30m : $\sigma$ < 9mm, 30m to 50m : $\sigma$ < 15mm Indoor : 1,000lx or less 0.1m to 50m : $\sigma$ < 15mm* <sup>5</sup> Outdoor: 100,000lx or less 90% Reflectance white Kent paper 0.1m to 50m : $\sigma$ < 9mm Indoor : 1,000lx or less 0.1m to 50m : $\sigma$ < 15mm* <sup>5</sup> Outdoor: 100,000lx or less
Scan angle	190°

Angular resolution/ Scan speed	20ms* <sup>6</sup> (Normal mode 3000rpm) / approx. 0.32° (360°/1125) 40ms* <sup>6</sup> (Low speed mode 1500rpm) / approx.0.16° (360°/2250) 80ms* <sup>6</sup> (High resolution mode 750rpm) / approx.0.08° (360°/4500)
Interface	Ethernet 100Base –TX (Auto-negotiation)
Outputs	PNP 7 OUTPUT: Synchronous master output, Synchronous output, Malfunction output, Contamination output, Area Detection 1, Area Detection 2, Area Detection 3 (For UGM-50LAP only)
Inputs	7 INPUT : Synchronous input, IP Reset Input, Reboot input, Area 1, Area 2, Area 3, Area 4 (Maximum area pattern : 15 patterns, for UGM-50LAP only)
Output response time	40msec or less (Normal mode) 80msec or less (Low speed mode) 160msec or less (High resolution mode) In either case, change depending upon the delay setting
Start up time	Within 30 sec
Indicator LED	4 LED (Yellow green, Orange, Blue, Red)
Ambient temperature and humidity	-10°C to +50°C, below 85% RH -30°C to +50°C, below 85% RH (While using the heater) *Without dew, frost
Storage temperature, humidity	-30°C to +50°C below 85% RH *Without dew, frost
Ambient illuminance	100,000lx* <sup>5</sup>
Weather resistance	Detective distance may shorten by rain, snow and sunlight.* <sup>7</sup>
Vibration resistance	10 to 150Hz 5G IEC60068-2-6:2007
Shock resistance	3 times 50G, 1000 times 25G IEC60068-2-27:2008
Protective structure	IP67 (IEC 60529: 2001)
Insulation resistance	10MΩ
Weight	Approx. 4.2kg (Sensor only, without cable)
Material	Optical window : Polycarbonate Body : Aluminum
Dimensions (W×D×H)	155mm × 166mm × 176mm (Without connector) External dimension: MC- 40 -03391

\*<sup>1</sup>Current consumption when heater power supply is not connected, or heater power supply is OFF

\*<sup>2</sup>Current consumed only by the heater.

\*<sup>3</sup>Indoor environment. (Fluorescent lamp should be 1,000lx or less.)

\*<sup>4</sup>When the high resolution mode (750rpm) is selected, the detection guarantee is 120m (white paper).

\*<sup>5</sup>Detection cannot be guaranteed when direct light (such as sunlight) enters the device.

\*<sup>6</sup>When you change the scan speed, it is necessary to reboot the sensor.

\*<sup>7</sup>Confirm the influence of the surrounding environment on detection by the actual product.



## 11. Applicable directives and standards

Table 11-1 shows the conformant EU directives and EN standards

Table 11-1 Directives and Standards

Directives/Standard	Details
Directives	EMC Directives RoHS Directives
EMC Directives	(EMI) EN61326-1:2013 EN55011:2009 + A1:2010 (EMS) EN61326-1:2013 EN61000-4-2:2009 EN61000-4-3:2006 + A1:2008 + A2:2010 EN61000-4-4:2012 EN61000-4-6:2014 EN61000-4-8:2010

- About the laser safety

The UGM laser safety standard is class 1.

Average laser power ···· 1mW or less

Wave length ······ 905nm (Infrared laser)

Peak Power ······ 40W

Pulse cycle ····· 55.5 KHz

Laser beam size ···· Approx. 250mm×40mm (Distance: 50m at the sensor's front (For detail refer to 4.1 sections)

Standard ······ IEC60825-1 (2014)

About Laser Safety Standard Class 1: under normal operation conditions (operations which can be foreseen rationally), it is guaranteed as safety class laser. Additional measures are not necessary to maintain laser safety.

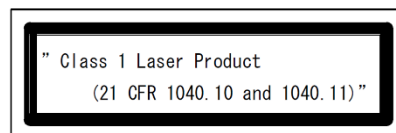
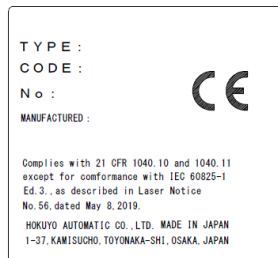

Figure 11-1 FDA Certified labels



**Caution**

- Do not look directly into a laser beam.
- Use of controls or adjustments or performance of procedures other than those specified herein may result in hazardous radiation exposure.

## 12. Package contents

The following items are included in the package:

- a) UGM-50LAP or UGM-50LXP ×1



- b) User's manual ×1



## 13. Options

### 13.1 Power supply connector

This cable connects power supply and Heater power with UGM.

Specification	Model	Code No.
Cable length 5m	UGM-4PC005	UZ00121

### 13.2 Ethernet connector

This cable connects PC with UGM. It is used for setting UGM and output the distance measurement data.

Specification	Model	Code No.
Cable length 5m	UGM-ENET005	UZ00122

### 13.3 I/O1 (8pin) connector

This cable connects an external controller with UGM. It is used for I/O1 (8pin) Input/Output of UGM.

Specification	Model	Code No.
Cable length 5m	UGM-8PC005	UZ00123

### 13.4 I/O2 (12pin) connector

This cable connects an external controller with UGM. It is used for I/O2 (12pin) Input/Output of UGM.

Specification	Model	Code No.
Cable length 5m	UGM-12PC005	UZ00124

### 13.5 Mounting bracket

#### ●Base mounting bracket

This base bracket can be used to change the vertical alignment of the UGM during installation. This bracket is useful especially in preventing the mutual interference when two or more UGMs are used. (Refer to external dimension)

#### ●Rear mounting bracket

This rear bracket can be used to change the vertical and horizontal alignment of the UGM during installation. This bracket is useful especially in preventing the mutual interference when two or more UGM are used. (Refer to external dimension)

#### ●Cover bracket

Cover brackets for optical window protection that can be used in combination with mounting brackets. (Refer to external dimension)

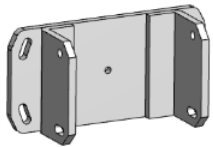
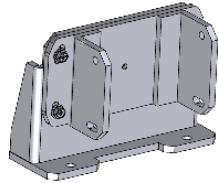
Specification	Model	Code No.	External dimensions
Rear mounting bracket	UGM-BK01	UZ00125	
Base mounting bracket	UGM-BK02	UZ00126	

## 14. External dimension

### 14.1 UGM-50LAP, UGM-50LXP

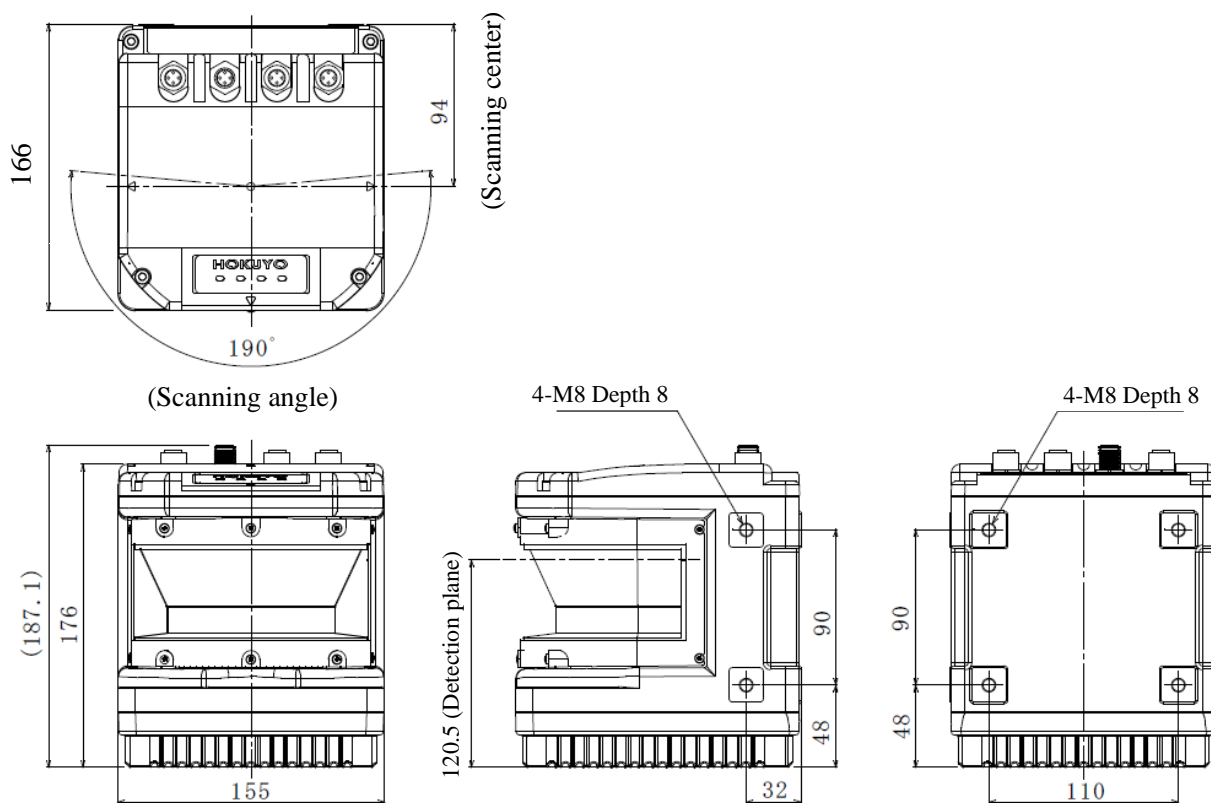

## 14.2 Rear mounting bracket

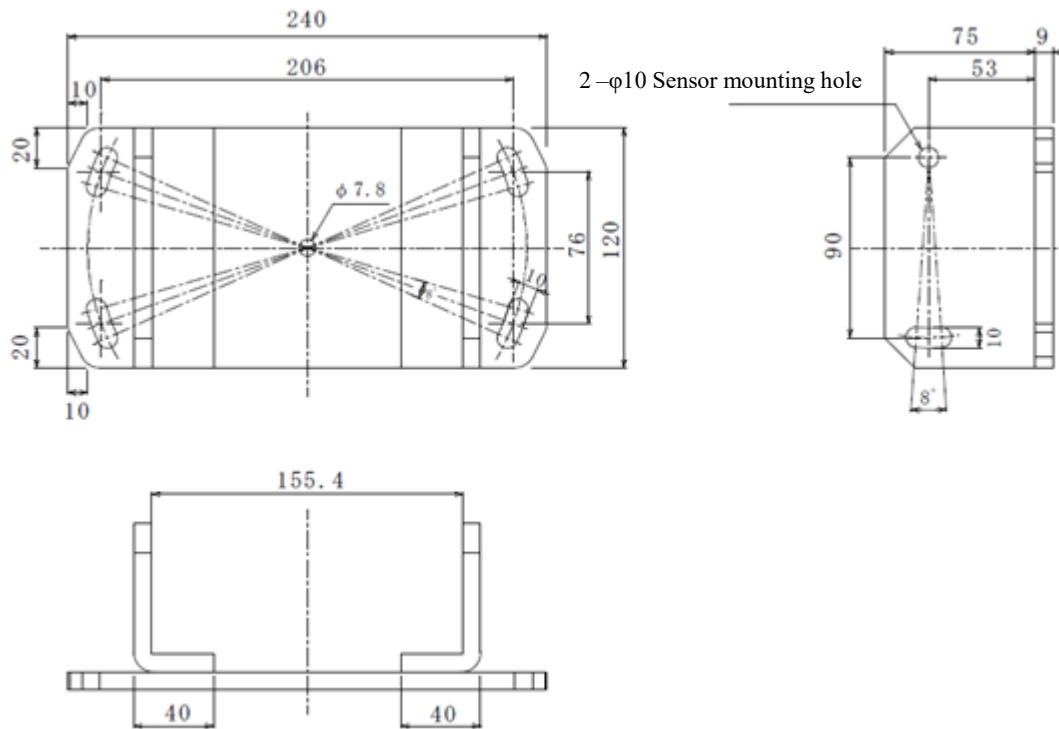

### 14.3 Base mounting bracket

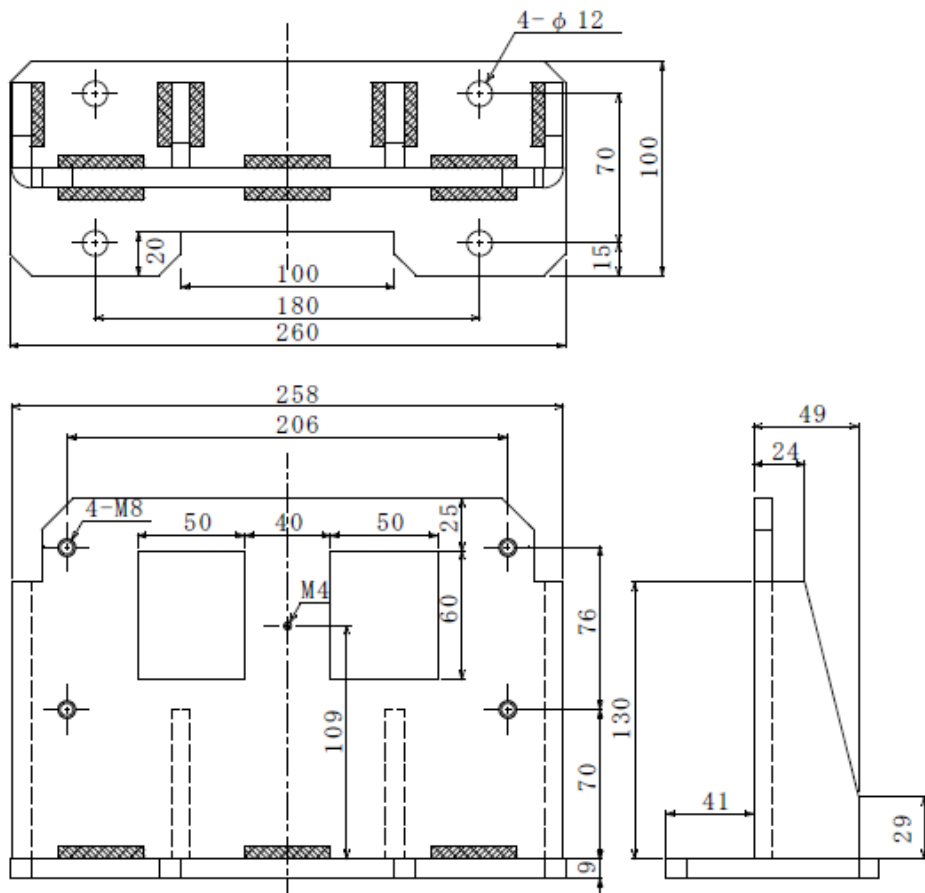

## 15. Revision history

Document No.	Amended No.	Revision date	Details
---	---	Mar. 2020	First Release
△ × 5	RS-01517	Jul. 2020	Malfunction output logic changing
△ × 6	RS-01606	Jan. 2021	Errors correction and Notation changes

★The contents described in this document are based on the information as of Jan., 2021. The external dimensions; specifications etc. are subject to change without notice.